



MAX9259 Evaluation Kit

General Description

The MAX9259 evaluation kit (EV kit) provides a proven design to evaluate the MAX9259 gigabit multimedia serial link (GMSL) with spread spectrum and full-duplex control channel. The EV kit also includes Windows® 2000, Windows XP®, and Windows Vista®-compatible software that provides a simple graphical user interface (GUI) for exercising the features of the MAX9259.

The MAX9259 EV kit comes with a MAX9259GCB/V+ installed.

For complete GMSL evaluation, order both the MAX9259 EV kit and its companion board, the MAX9260 EV kit.

Features

- ◆ Accepts 29-Bit Parallel Video and I²S Audio
- ◆ On-Board S/PDIF-to-I²S Audio Converter
- ◆ Windows 2000-, Windows XP-, and Windows Vista (32-Bit)-Compatible Software
- ◆ USB-PC Connection (Cable Included)
- ◆ USB Powered
- ◆ Proven PCB Layout
- ◆ Fully Assembled and Tested

Ordering Information

PART	TYPE
MAX9259EVKIT+	EV Kit

+Denotes lead(Pb)-free and RoHS compliant.

Note: The MAX9259 EV kit should be ordered with its companion board, the MAX9260 EV kit.

Component List

DESIGNATION	QTY	DESCRIPTION
C1-C7	7	0.01µF ±10%, 25V X7R ceramic capacitors (0402) Murata GRM155R71E103K
C8-C14, C17, C101-C105, C111, C121, C131, C141, C151, C211-C214, C221, C231, C241, C251	26	0.1µF ±10%, 16V X7R ceramic capacitors (0603) TDK C1608X7R1C104K
C15, C16	2	0.22µF ±10%, 50V X7R ceramic capacitors (0805) Murata GRM21BR71H224K
C21, C261	2	4.7µF ±20%, 25V X7R ceramic capacitors (1206) Murata GCM31CR71E475M
C22, C24, C25, C26, C109, C262, C264, C267	8	10µF ±20%, 16V X5R ceramic capacitors (1206) Murata GRM31CR61C106M
C23, C263	0	Not installed, capacitors (1206)

DESIGNATION	QTY	DESCRIPTION
C106, C107, C122, C123	4	22pF ±5%, 50V C0G ceramic capacitors (0603) Murata GRM1885C1H220J
C108, C265, C268	3	1µF ±10%, 16V X5R ceramic capacitors (0603) TDK C1608X5R1C105K
C110	1	0.033µF ±10%, 25V X7R ceramic capacitor (0603) Murata GRM188R71E333K
C201, C202, C203	3	1µF ±20%, 6.3V X5R ceramic capacitors (0402) TDK C1005X5R0J105M
C205, C206, C232, C266, C269	5	0.01µF ±5%, 25V C0G ceramic capacitors (0603) TDK C1608C0G1E103J
C207	1	1000pF ±10%, 50V X7R ceramic capacitor (0805) Murata GCM216R71H102K
C208	1	0.022µF ±10%, 25V X7R ceramic capacitor (0402) TDK C1005X7R1E223K
C233	0	Not installed, capacitor (0603)

Windows, Windows XP, and Windows Vista are registered trademarks of Microsoft Corp.



MAX9259 Evaluation Kit

Evaluates: MAX9259

Component List (continued)

DESIGNATION	QTY	DESCRIPTION
H1	1	72-pin header (2 x 36)
J1	1	High-speed automotive connector Rosenberger D4S20F-40MA5-Z
J2, J3, J23	0	Not installed, SMA connectors
J4	0	Not installed Nissei GT11L-2S/JAE MX38-FF
J5	0	Not installed JAE MX49Z04NQ1
J10	1	USB type-B, right-angle female receptacle
J21	1	Phono jack
JU1–JU9, JU121, JU151, JU152	12	3-pin headers
JU10, JU21, JU22, JU23, JU153, JU154, JU191–JU194, JU210, JU261	12	2-pin headers
JU19 (x6, see Table 1)	6	0Ω ±5% resistors (0603)
JU101–JU108, JU141–JU144, JU211–JU214	0	Not installed, 2-pin headers— shorted with PCB trace
L21, L22, L23, L101, L261	5	Ferrite beads (0603) TDK MMZ1608R301A
L262	1	3.3μH ±10% inductor (0805) Murata LQM21NN3R3K10
LED1, LED120, LED151– LED158	10	Red LEDs (0805)
LED2	1	Green LED (0805)
Q1, Q2	2	n-channel MOSFETs (SOT23) Central Semi 2N7002
R1, R2	2	45.3kΩ ±1% resistors (0603)
R3, R4	2	4.99kΩ ±1% resistors (0603)
R5, R11, R12, R111	4	2.2kΩ ±5% resistors (0603)
R13	1	0Ω ±5% resistor (0603)

μMAX is a registered trademark of Maxim Integrated Products, Inc.

DESIGNATION	QTY	DESCRIPTION
R14, R15, R123, R151–R158, R203	12	1kΩ ±5% resistors (0603)
R101, R102	2	27Ω ±5% resistors (0603)
R103	1	1.5kΩ ±5% resistor (0603)
R104	1	470Ω ±5% resistor (0603)
R112, R122, R211, R212	4	10kΩ ±5% resistors (0603)
R121	1	1.1kΩ ±5% resistor (0603)
R191, R192, R201, R202	4	4.7kΩ ±5% resistors (0603)
R205	1	75kΩ ±5% resistor (0603)
R208	1	3.01kΩ ±1% resistor (0603)
R233	0	Not installed, resistor (0603)
SW1	1	Miniature SPDT toggle switch
SW122, SW150– SW157, SW221	10	Momentary pushbutton switches (6mm)
U1	1	Gigabit multimedia serial link (64 TQFP-EP*) Maxim MAX9259GCB/V+
U2	1	1.8V, 500mA LDO regulator (8 μMAX®-EP*) Maxim MAX1792EUA18+ (Top Mark: AAAA)
U10	1	UART-to-USB converter (32 TQFP)
U11	1	93C46 type 3-wire EEPROM 16-bit architecture (8 SO)
U12	1	Ultra high-speed microcontroller (44 TQFP) Maxim DS89C450-ENL+
U13	1	Quad three-state buffer (14 SO) Fairchild 74AC125SC_NL
U14	1	Level translator (14 TSSOP) Maxim MAX3378EEUD+
U15	1	I ² C I/O expander (24 QSOP) Maxim MAX7324AEG+
U19	1	Dual bidirectional level translator (8 SOT23) Maxim MAX3373EEKA+ (Top Mark: AAKS)
U20	1	Digital audio receiver (28 TSSOP)

MAX9259 Evaluation Kit

Evaluates: MAX9259

Component List (continued)

DESIGNATION	QTY	DESCRIPTION
U21	1	16-bit, dual-supply bus transceiver (48 TSSOP)
U22	1	Low-power, dual-voltage μ P supervisor (5 SC70) Maxim MAX6736XKTGD3+ (Top Mark: AFS)
U23, U24	2	2:1 noninverting multiplexers (SC70) Fairchild NC7SV157P6X_NL (Top Mark: VF7)
U25	1	Schmitt trigger buffer (5 SC70) Fairchild NC7SV17P5X_NL (Top Mark: V17)
U26	1	3.3V, 500mA LDO regulator (8 μ MAX-EP*) Maxim MAX1792EUA33+ (Top Mark: AAAC)

DESIGNATION	QTY	DESCRIPTION
Y1	0	Not installed, crystal oscillator (14 DIP)
Y10	1	6MHz crystal (HCM49) Hong Kong X'tals SSL60000N1HK188F0-0
Y12	1	14.7456MHz crystal (HCM49) Hong Kong X'tals SSM14745N1HK188F0-0
Y23	1	12MHz, 3.3V low-jitter clock (7mm x 5mm)
—	1	USB high-speed A-to-B cables, 6ft
—	22	Shunts
—	1	PCB: MAX9259 EVALUATION KIT+

*EP = Exposed pad.

Component Suppliers

SUPPLIER	PHONE	WEBSITE
Central Semiconductor Corp.	631-435-1110	www.centalsemi.com
Fairchild Semiconductor	888-522-5372	www.fairchildsemi.com
Hong Kong X'tals Ltd.	852-35112388	www.hongkongcrystal.com
Murata Electronics North America, Inc.	770-436-1300	www.murata-northamerica.com
Rosenberger Hochfrequenztechnik GmbH	011-49-86 84-18-0	www.rosenberger.de
TDK Corp.	847-803-6100	www.component.tdk.com

Note: Indicate that you are using the MAX9259 when contacting these component suppliers.

MAX9259 EV Kit Files

FILE	DESCRIPTION
MAX9259.EXE	Application program
FTD2XX.INF	USB device driver file
UNINST.INI	Uninstalls the EV kit software
USB_Driver_Help.PDF	USB driver installation help file

MAX9259 Evaluation Kit

Quick Start

Required Equipment

- MAX9259 EV kit (USB cable included)
- MAX9260 EV kit (USB cable included)
- 2m Rosenberger cable assembly (included in MAX9260 EV kit)
- Parallel data source (e.g., digital video)
- Optional: Function generator (needed only if parallel data lacks a pixel clock)
- Optional: I²S or S/PDIF audio source
- Optional: Pair of 8Ω speakers
- Optional: 3.5mm stereo headphones (16Ω or greater)
- User-supplied Windows 2000, Windows XP, or Windows Vista PC with a spare USB port (direct 500mA connection required; do not use a hub)

Note: In the following sections, software-related items are identified by bolding. Text in **bold** refers to items directly from the EV kit software. Text in **bold and underlined** refers to items from the Windows operating system.

Procedure

The MAX9259 EV kit is fully assembled and tested. Follow the steps below to verify board operation:

- 1) Visit www.maxim-ic.com/evkitsoftware to download the latest version of the EV kit software, 9259Rxx.ZIP. Save the EV kit software to a temporary folder and uncompress the ZIP file.
- 2) Install the EV kit software on your computer by running the 9259Rxx.msi program inside the temporary folder. The program files are copied and icons are created in the Windows **Start | Programs** menu.
- 3) Verify that all jumpers are in their default positions, as shown in Table 1.
- 4) Connect the Rosenberger cable from MAX9259 EV kit connector J1 to MAX9260 EV kit connector J1.
- 5) Connect the parallel data source to header H1 (if using static data without a pixel clock, use an external function generator to drive PCLK_IN).
- 6) *Optional Audio Demo:* Connect the S/PDIF audio source (e.g., DVD player digital output) to MAX9259 EV kit phono jack J21. Or, connect an I²S audio source to header H1 and remove jumper JU210. Connect speakers to MAX9260 EV kit SPKR_L+/SPKR_L- and SPKR_R+/SPKR_R- oval pads, or plug headphones into J206 headphone jack.
- 7) Connect the USB cable from the PC to the MAX9259 EV kit board (direct 500mA connection required; do not use a hub). A **New Hardware Found** window pops up when installing the USB driver for the first time. If a window is not seen that is similar to the one described above after 30s, remove the USB cable from the board and reconnect it. Administrator privileges are required to install the USB device driver on Windows.
- 8) Follow the directions of the **Found New Hardware** window to install the USB device driver. Manually specify the location of the device driver to be **C:\Program Files\MAX9259** (default installation directory) using the **Browse** button. During device driver installation, Windows may show a warning message indicating that the device driver Maxim uses does not contain a digital signature. This is not an error condition and it is safe to proceed with installation. Refer to the USB_Driver_Help.PDF document included with the software for additional information.
- 9) Verify that MAX9259 EV kit LED120 lights up, indicating that the microcontroller is powered and enabled.
- 10) Verify that MAX9260 EV kit LED120 lights up, indicating that the microcontroller is powered and enabled.
- 11) Verify that MAX9260 EV kit LED2 lights up, indicating that the link has been successfully established. If LED2 is off or LED1 is on, double-check that the PCLK_IN signal is clocking data.
- 12) *Optional Audio Demo:* Press and release switch SW122 on both of the MAX9259 and MAX9260 EV kits to enable this S/PDIF-to-I²S and I²S-to-audio DAC demonstration circuitry. If I²S or S/PDIF audio was provided to the MAX9259 EV kit, audio should now be heard from the speakers or headphones previously connected to the MAX9260 EV kit.
- 13) Start the MAX9259 EV kit software by opening its icon in the **Start | Programs** menu. The EV kit software configuration window appears, as shown in Figure 7.
- 14) Press the **Connect** button and the configuration window disappears.
- 15) The EV kit software main window appears, as shown in Figure 1.
- 16) Press the **Read All** button to read all registers on the MAX9259 and MAX9260.

MAX9259 Evaluation Kit

- 17) *I²C Slave Device Demo*: Make sure MAX9260 EV kit jumpers JU151–JU154 are in the 1-2 position.
- 18) In the software's MAX7324 tab (Figure 4), press the **Search for MAX7324** button. Verify that the **MAX7324 Device Address** drop-down list shows **0xDA (JU151=1-2 JU152=1-2)**.
- 19) Press the **LED151-LED158 ON** button. Verify that MAX9260 EV kit LED151–LED158 turn on.
- 20) Press the **LEDs Alternating** button. Verify that MAX9260 EV kit LED151, LED153, LED156, and LED158 turn off.
- 21) *GPIO Demo*: In the software's MAX9260 tab (Figure 3), scroll down to **Register 0x06**. Uncheck the **GPIO1OUT** checkbox and press the **Write** button. Verify that MAX9260 EV kit LED4 turns off.
- 22) Uncheck the **GPIO0OUT** checkbox and press the **Write** button. Verify that MAX9260 EV kit LED3 turns off.
- 23) Check the **GPIO1OUT** checkbox and press the **Write** button. Verify that MAX9260 EV kit LED4 turns on.
- 24) Check the **GPIO0OUT** checkbox and press the **Write** button. Verify that MAX9260 EV kit LED3 turns on.
- 25) *INT Demo*: Toggle MAX9260 EV kit switch SW2 up. Verify that MAX9259 EV kit LED1 turns on, indicating that MAX9260 INT input is asserted.
- 26) In the software's MAX9260 tab, scroll to **Register 0x06** and press the **Read** button. Verify that the **INT** checkbox is checked, indicating that MAX9260 INT input is asserted.
- 27) Toggle MAX9260 EV kit switch SW2 down. Verify that MAX9259 EV kit LED1 turns off, indicating that MAX9260 INT input is not asserted.
- 28) In the software's MAX9260 tab, scroll to **Register 0x06** and press the **Read** button. Verify that the **INT** checkbox is not checked, indicating that MAX9260 INT input is not asserted.

Detailed Description of Software

The main window of the evaluation software (Figure 1) shows a block diagram representing the MAX9259/MAX9260 system. The left column shows MAX9259 input data sources, and the right column shows MAX9260 output data sinks.

The **Change Configuration** button (Figure 1) brings up the **Configuration** window (Figure 7), allowing the software GUI to select which side of the link the USB cable should be plugged in to. Controlling from the

MAX9260 side requires changing some jumper settings as described in this window. If the MAX9259 and MAX9260 device addresses have been previously changed from their factory power-on-reset values, the new addresses must be specified in the **Configuration** window to allow register access.

The **Baud Rate** drop-down list sets the communications baud rate. The USB link uses the same baud rate as the MAX9259/MAX9260. Note that the baud rate should only be changed one step at a time.

The **Read All** button reads all of the MAX9259/MAX9260 device registers. The **Reset to Default Values** button restores recommended factory settings, and the **Write All** button writes all MAX9259 and MAX9260 device registers with the values shown in the GUI.

The **MAX9259** tab sheet (Figure 2) provides direct access to all registers of the MAX9259 and the **MAX9260** tab sheet (Figure 3) provides direct access to all registers of the MAX9260. Each register has its own **Read** and **Write** button. The small circle next to the **Read** button turns yellow to indicate an attempt to read or write, red to indicate a failed read or write, and green to indicate a successful read or write operation.

The **MAX7324** tab sheet (Figure 4) controls the I²C I/O expander on the remote side of the link. When USB is plugged into the MAX9259 EV kit, the MAX7324 tab sheet controls the MAX7324 (U15) on the MAX9260 EV kit. Note that the MAX7324 actually has two device addresses; for simplicity, the software GUI only displays the device address associated with MAX7324 outputs. For details, refer to the MAX7324 IC data sheet.

The **PRBS Test** tab sheet (Figure 5) uses the MAX9260 registers to perform a pseudorandom bit sequence (PRBS) error-rate test. Select the test duration (maximum 32767s = 9.1hrs) and press the **Start** button. The software GUI configures the MAX9260 to begin the PRBS test, counts down the specified delay time, and then reports the final value of the MAX9260 PRBSERR register.

The **Interface History and Low Level Access** tab sheet (Figure 6) shows the recent low-level communications activity between the software GUI and the MAX9259/MAX9260. The **Register Access** group box provides arbitrary device read/write control, supporting additional user-supplied devices besides the on-board MAX9259, MAX9260, and MAX7324. The **Device Address**, **Register**, and **Data** drop-down lists specify the device address and the register within the device, as well as one optional byte of data to be written. Pressing the **Write Register** button writes one byte of data to

MAX9259 Evaluation Kit

the specified device register. **Read Register** reads the specified device register and reports the results into the **Interface History** window. Devices that are not register-based (such as the MAX7324) are supported by **Send Data (no register)** and **Receive Data (no register)**. User-supplied devices requiring other interface protocols must use **Raw TX byte codes** to communicate. Note that in bypass mode, raw data is passed to the user-supplied slave device directly without modification.

Detailed Description of Hardware

The MAX9259 EV kit provides a proven layout for the MAX9259. On-board level translators, S/PDIF-to-I²S audio, and an easy-to-use USB-PC connection are included on the EV kit.

The MAX9259 EV kit board layout is divided into four principal sections.

From header H1 to connector J1 are the support components specific to the MAX9259. On-board LDO regulator U2 powers the AVDD, DVDD, and IOVDD supplies from VIN. Jumper JU9 optionally connects VIN to the link cable, powering the remote EV kit board.

Below header H1, the board layout has three sections: microcontroller (U10–U14), I²C slave device (U15), and audio (U20–U25). The microcontroller and I²C slave device sections are identical on the MAX9259 and MAX9260 EV kits.

The audio section of the MAX9259 EV kit contains S/PDIF-to-I²S audio converter circuits (U20–U25), which can be disabled by JU210 for applications already having I²S audio.

The audio section of the MAX9260 EV kit contains I²S-to-audio DAC circuits (U20, U21) and a Class D stereo power amplifier (U25). The audio DAC circuits are similar to the MAX9850 EV kit, and the power amplifier circuit is similar to the MAX9701 EV kit.

User-Supplied Interface

To use the MAX9259 EV kit with a user-supplied interface, first cut the PCB traces at jumpers JU141 and JU142. Next, apply your own TX/SCL signal at the U1 side of JU141 and RX/SDA at the U1 side of JU142. Refer to the MAX9259/MAX9260 IC data sheet for details about UART protocol for base mode, write data format, read data format, selecting base mode or bypass mode, and selecting UART or I²C slave device.

User-Supplied Power Supply

The MAX9259 and MAX9260 EV kits are powered completely from the USB port by default. The 5V USB bus

power is supplied to the remote EV kit over the link cable by default. Jumper JU10 powers the link cable (VBUS) from the 5V USB supply, and jumper JU9 connects VBUS to the VIN power supply.

To provide external power to each EV kit's VIN, and still power both microcontrollers from USB, remove the shunt from jumper JU9, but leave the shunt at jumper JU10 installed. VBUS carries the USB 5V bus power to the remote EV kit board, but external user-supplied VIN supplies are required to power the MAX9259 and the MAX9260.

To provide different power supplies to DVDD, AVDD, and IOVDD, remove the shunts from jumpers JU21, JU22, and JU23, and apply external user-supplied power at the DVDD, AVDD, and IOVDD oval pads.

The I²S audio link demonstration requires both MAX9259 EV kit and MAX9260 EV kit microcontrollers (U12) to be powered, otherwise the on-board S/PDIF-to-I²S converter or the I²S audio DAC does not initialize.

Detailed Description of Firmware

The DS89C450 microcontroller (U12) runs custom firmware, which ensures that no breaks occur within register read/write commands. The firmware records 9-bit, even-parity data received from the USB interface while RTS is set, and plays back the 9-bit data with 1.5 stop bits timing when RTS is cleared. Data received from the MAX9259 is relayed to USB immediately.

The audio chips are initialized by an I²C command sequence sent by the firmware when the microcontroller is reset. The same firmware runs on both the MAX9259 and MAX9260 EV kit boards, so this initialization sequence covers both the S/PDIF-to-I²S converter and the MAX9850 I²S stereo audio DAC. Pressing switch SW122 resets the microcontroller, resending the audio I²C initialization commands.

The firmware also supports a small set of commands, available when RTS is clear. Since all register read/write requests are sent with RTS set, there is no conflict between register data and firmware commands. These firmware commands are issued automatically by the MAX9259 EV kit software GUI. The following information is provided for reference only.

Firmware command “?” prints the firmware version banner message and brief command list.

Firmware command “B” changes the baud rate by changing the internal TH1 baud-rate divisor. Refer to firmware help command “?” for details. Pressing switch

MAX9259 Evaluation Kit

Evaluates: MAX9259

SW122 resets the USB baud rate to 921600 baud. The software GUI automatically sends the baud-rate change command.

Firmware command “T” supports waking up the MAX9259 from the MAX9260 side of the link. Command “T” performs a dummy read, followed by a delay on the order of 1ms to 8ms, and finally writes a register value. For

example, send “T810558800483” to read from device address 0x81 register 0x05, delay 4ms, then write to device address 0x80 register 0x04 data 0x83. This is the MAX9259 wake up sequence for the default device addresses. The software GUI automatically sends this command when the **Wake Up MAX9259** button is pressed.

Table 1. MAX9259 EV Kit Jumper Descriptions

JUMPER	SIGNAL	SHUNT POSITION	DESCRIPTION
JU1	CDS	1-2	CDS = high; optional peripheral attached to MAX9259
		2-3*	CDS = low; ECU attached to MAX9259; connect USB to MAX9259 EV kit
		Open	Reserved
SW1	MS	1-2 (toggle switch up)	MS = high; full-duplex bypass mode; device registers not accessible
		2-3 (toggle switch down)	MS = low; half-duplex base mode; required when writing to device registers or when using an external I ² C peripheral
JU2	BWS	1-2*	BWS = high
		2-3	BWS = low
JU3	ES	1-2*	ES = high
		2-3	ES = low
JU4	DRS	1-2*	DRS = high
		2-3	DRS = low
JU5	SSEN	1-2*	SSEN = high
		2-3	SSEN = low
JU6	$\overline{\text{PWDN}}$	1-2*	$\overline{\text{PWDN}}$ = high
		2-3	$\overline{\text{PWDN}}$ = low
JU7	$\overline{\text{AUTOS}}$	1-2*	$\overline{\text{AUTOS}}$ = high
		2-3	$\overline{\text{AUTOS}}$ = low
JU8	H1 odd pins	Open*	H1 odd-numbered pins connect to GND through R13
		1-2	H1 odd-numbered pins connect to IOVDD; R13 must be open
		2-3	H1 odd-numbered pins connect to GND
JU9	Bus power	1-2*	J1 pin 1, J4 pin 1, and J5 pin 1 connect to VIN
		2-3	J1 pin 1, J4 pin 1, and J5 pin 1 connect to GND
		Open	J1 pin 1, J4 pin 1, and J5 pin 1 not connected
JU10	Bus power	1-2*	J1 pin 1, J4 pin 1, and J5 pin 1 connect to USB 5V
		Open	USB power is not connected to link cable power

MAX9259 Evaluation Kit

Evaluates: MAX9259

Table 1. MAX9259 EV Kit Jumper Descriptions (continued)

JUMPER	SIGNAL	SHUNT POSITION	DESCRIPTION
JU19	OUT+, OUT-	Pads 2 and 4, Pads 4 and 5, Pads 5 and 7, Pads 13 and 11, Pads 11 and 10, Pads 10 and 8	Path to connector J1 (Rosenberger D4S10A-40ML5)
		Pads 2 and 4, Pads 4 and 1, Pads 1 and 10, Pads 10 and 9, Pads 13 and 12	Path to connector J4 (optional JAE MX38-FF or Nissei GT11L-2S)
		Pads 2 and 3, Pads 13 and 11, Pads 11 and 1, Pads 1 and 5, Pads 5 and 6	Path to connector J5 (optional JAE MX49Z04NQ1)
		Open	Disconnect from J1, J4, J5; use SMA connector option J2/J3
JU21	AVDD	1-2*	AVDD power from 1.8V LDO U2, powered by VIN
		Open	AVDD must be provided from an external source
JU22	DVDD	1-2*	DVDD power from 1.8V LDO U2, powered by VIN
		Open	DVDD must be provided from an external source
JU23	IOVDD	1-2*	IOVDD power from 1.8V LDO U2, powered by VIN
		Open	IOVDD must be provided from an external source
JU121	Reserved	Not installed*	Reserved for factory diagnostic tests
JU141	TX/SCL	Not installed*	Connects U1 to U12 through level translator U14
JU142	RX/SDA	Not installed*	Connects U1 to U12 through level translator U14
JU143	LFLT	Not installed*	Connects U1 to USB through level translator U14
JU144	INT	Not installed*	Connects U1 to USB through level translator U14
JU151	U15 AD2	1-2*	Selects U15 I ² C device address
		2-3	Selects U15 I ² C device address
		Open	Reserved for factory diagnostic tests
JU152	U15 AD0	1-2*	Selects U15 I ² C device address
		2-3	Selects U15 I ² C device address
		Open	Reserved for factory diagnostic tests
JU153	U15 SDA	1-2*	Connects U15 MAX7324 to I ² C bus; MS must be low (SW1) and CDS must be high (JU1 = 1-2 on both boards)
		Open	Disconnects U15 MAX7324 from I ² C bus; MS may be high (SW1)
JU154	U15 SCL	1-2*	Connects U15 MAX7324 to I ² C bus; MS must be low (SW1) and CDS must be high (JU1 = 1-2 on both boards)
		Open	Disconnects U15 MAX7324 from I ² C bus; MS may be high (SW1)
JU191	AUDIO-SCL	1-2*	U12 sends I ² C initialization commands to audio chip U20
		Open	Disconnects audio I ² C bus pullup resistor

MAX9259 Evaluation Kit

Evaluates: MAX9259

Table 1. MAX9259 EV Kit Jumper Descriptions (continued)

JUMPER	SIGNAL	SHUNT POSITION	DESCRIPTION
JU192	AUDIO-SDA	1-2*	U12 sends I ² C initialization commands to audio chip U20
		Open	Disconnects audio I ² C bus
JU193	AUDIO-SCL	1-2*	U12 sends I ² C initialization commands to audio chip U20
		Open	Disconnects audio I ² C bus pullup resistor
JU194	AUDIO-SDA	1-2*	U12 sends I ² C initialization commands to audio chip U20
		Open	Disconnects audio I ² C bus
JU210	U21 OE	1-2*	J21 S/PDIF input drives I ² S audio to H1 and U1
		Open	External user-supplied I ² S can be connected to H1
JU211	I ² S WS	Not installed*	J21 S/PDIF input drives I ² S audio to H1 and U1
		Open	Disconnects I ² S signals
JU212	I ² S SCK	Not installed*	J21 S/PDIF input drives I ² S audio to H1 and U1
		Open	Disconnects I ² S signals
JU213	I ² S SD	Not installed*	J21 S/PDIF input drives I ² S audio to H1 and U1
		Open	Disconnects I ² S signals
JU214	I ² S MCLK	Not installed*	J21 S/PDIF input drives I ² S audio to H1 and U1
		Open	Disconnects I ² S master clock
JU261	VMOD	1-2*	VMOD audio power from +3.3V LDO U26, powered by VIN
		Open	VMOD audio power must be provided from an external +3.3V source

*Default position.

Evaluates: MAX9259

MAX9259 Evaluation Kit

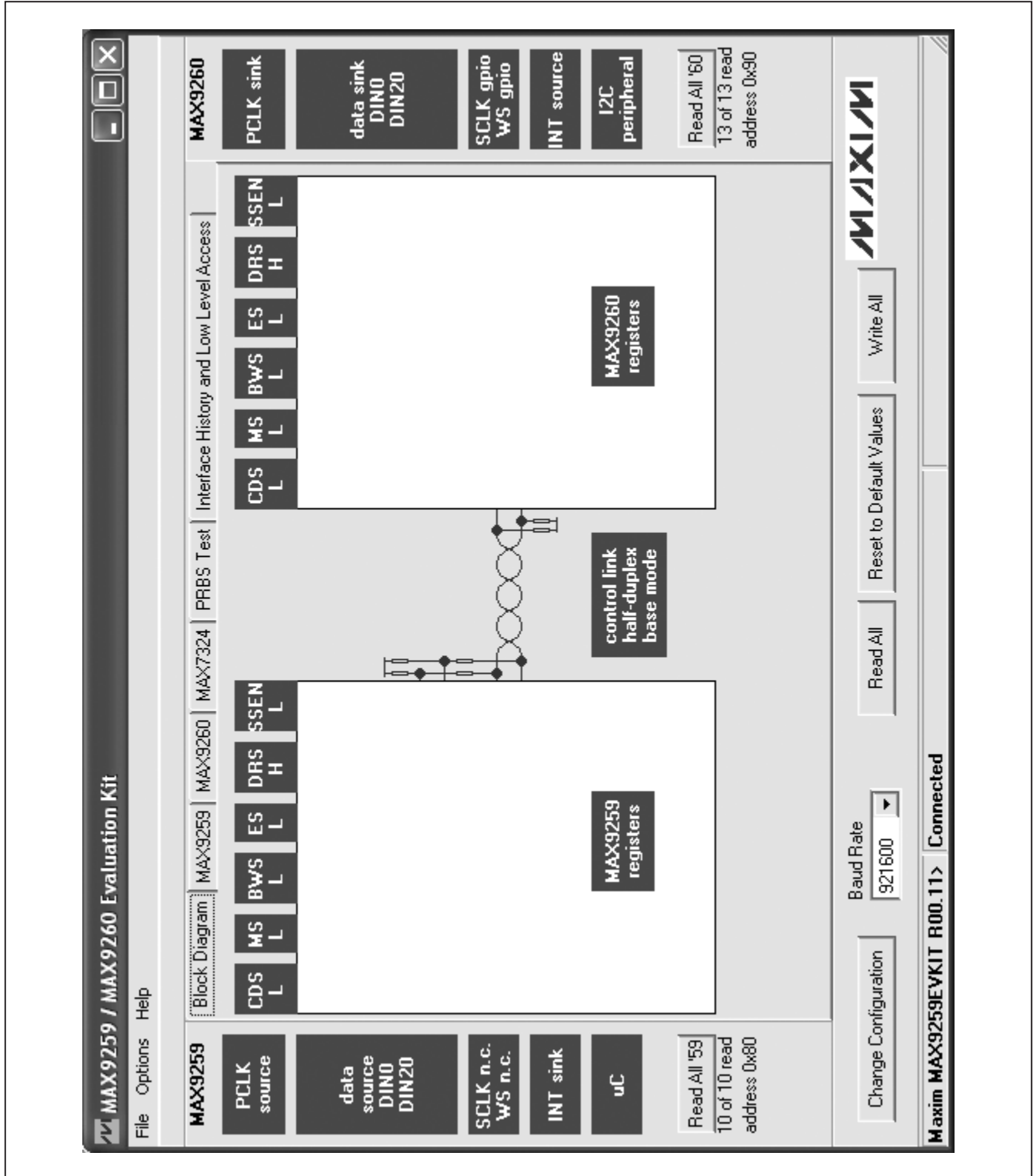

Figure 1. MAX9259/MAX9260 EV Kit Software Main Window (Block Diagram Tab)

MAX9259 Evaluation Kit

Evaluates: MAX9259

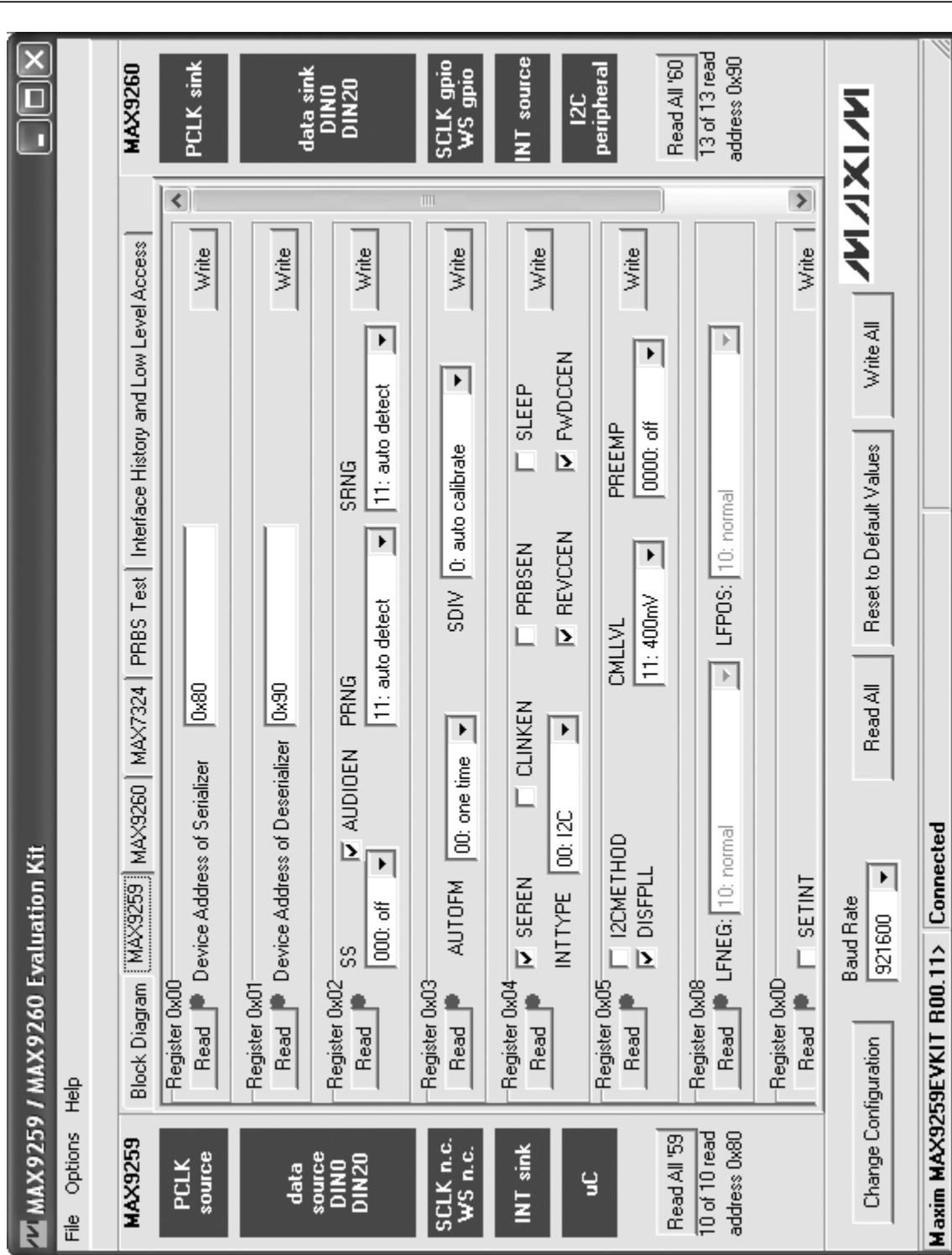

Figure 2. MAX9259/MAX9260 EV Kit Software Main Window (MAX9259 Tab)

MAX9259 Evaluation Kit

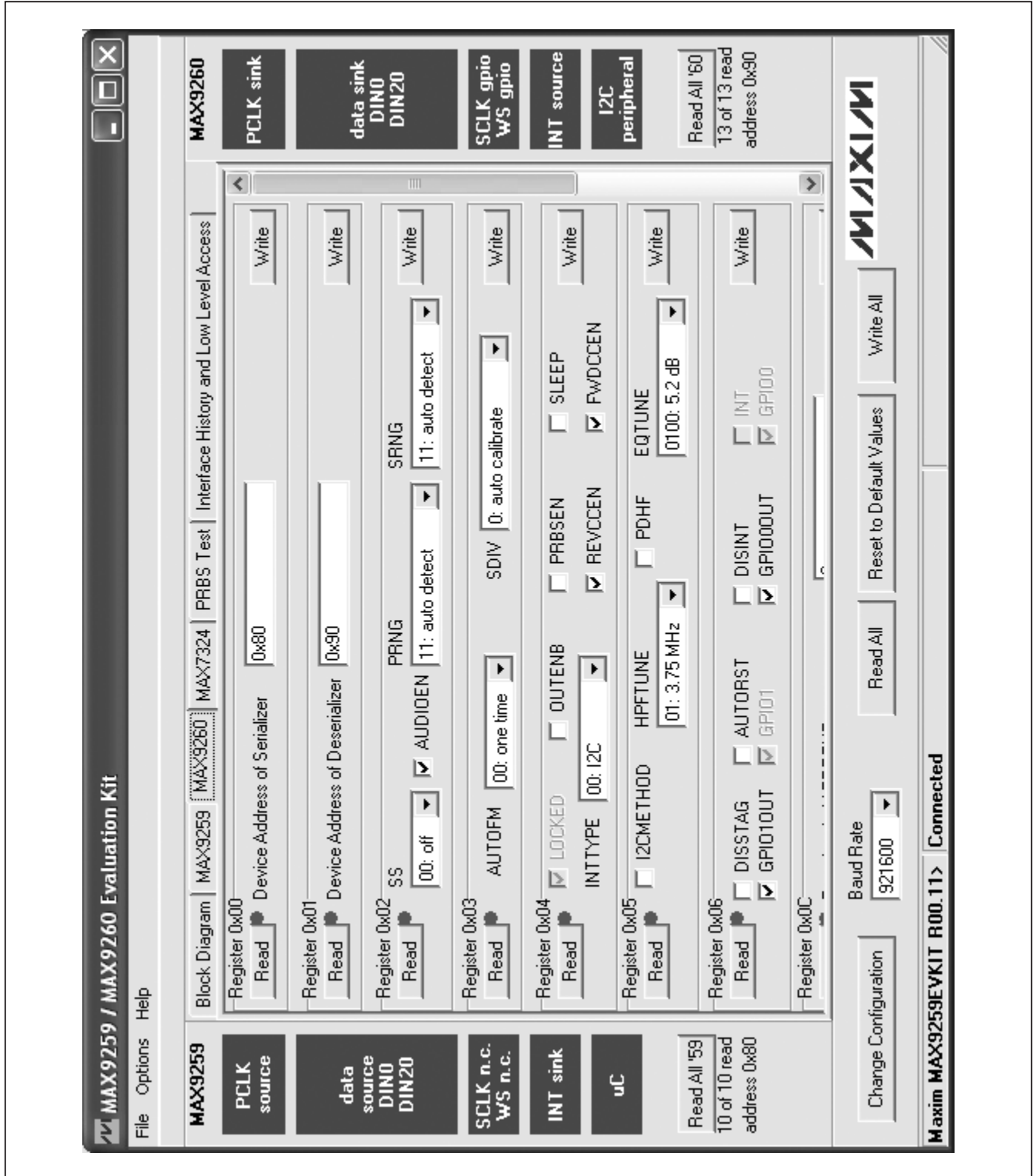

Figure 3. MAX9259/MAX9260 EV Kit Software Main Window (MAX9260 Tab)

MAX9259 Evaluation Kit

Evaluates: MAX9259

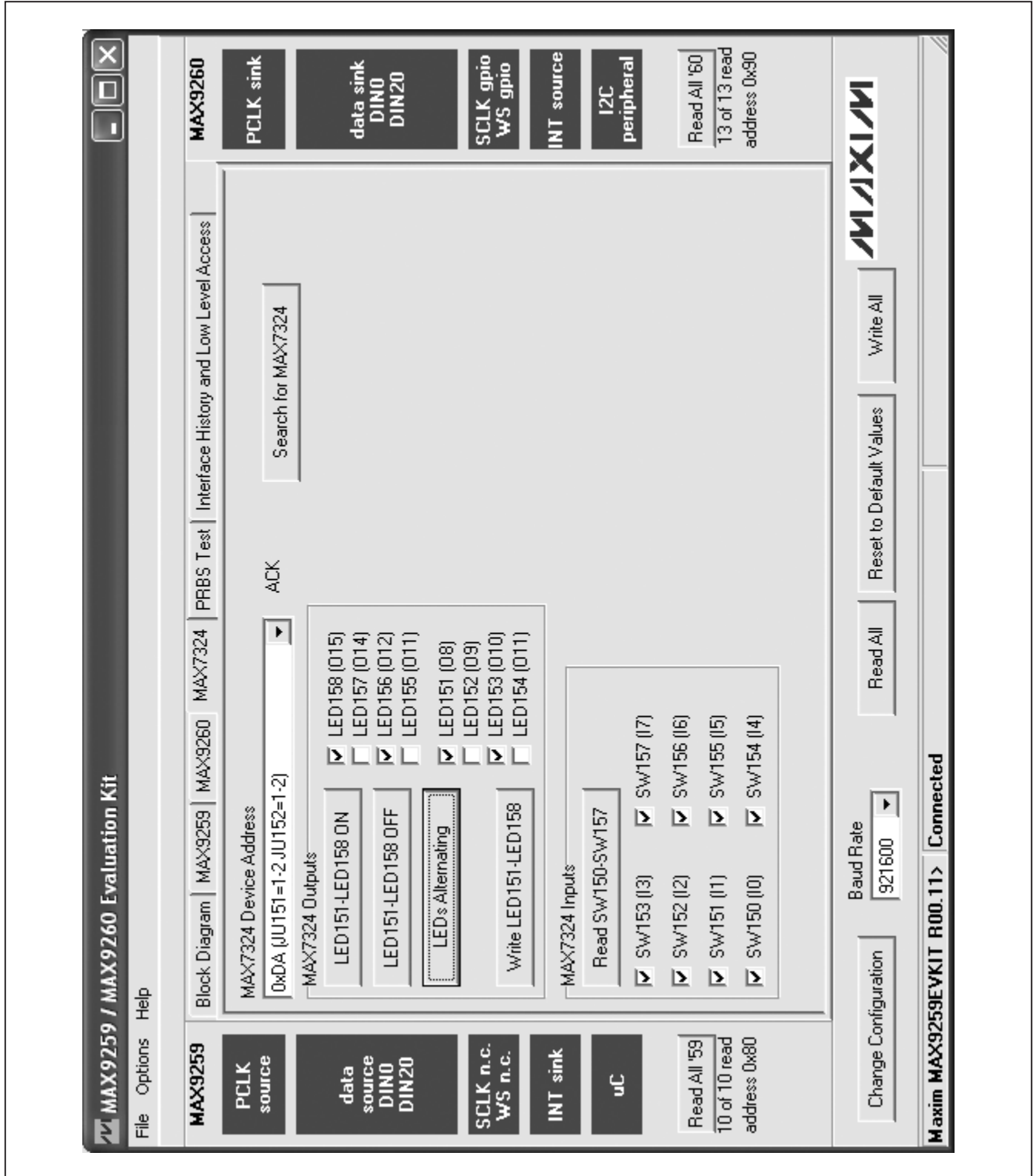

Figure 4. MAX9259/MAX9260 EV Kit Software Main Window (MAX7324 Tab)

MAX9259 Evaluation Kit

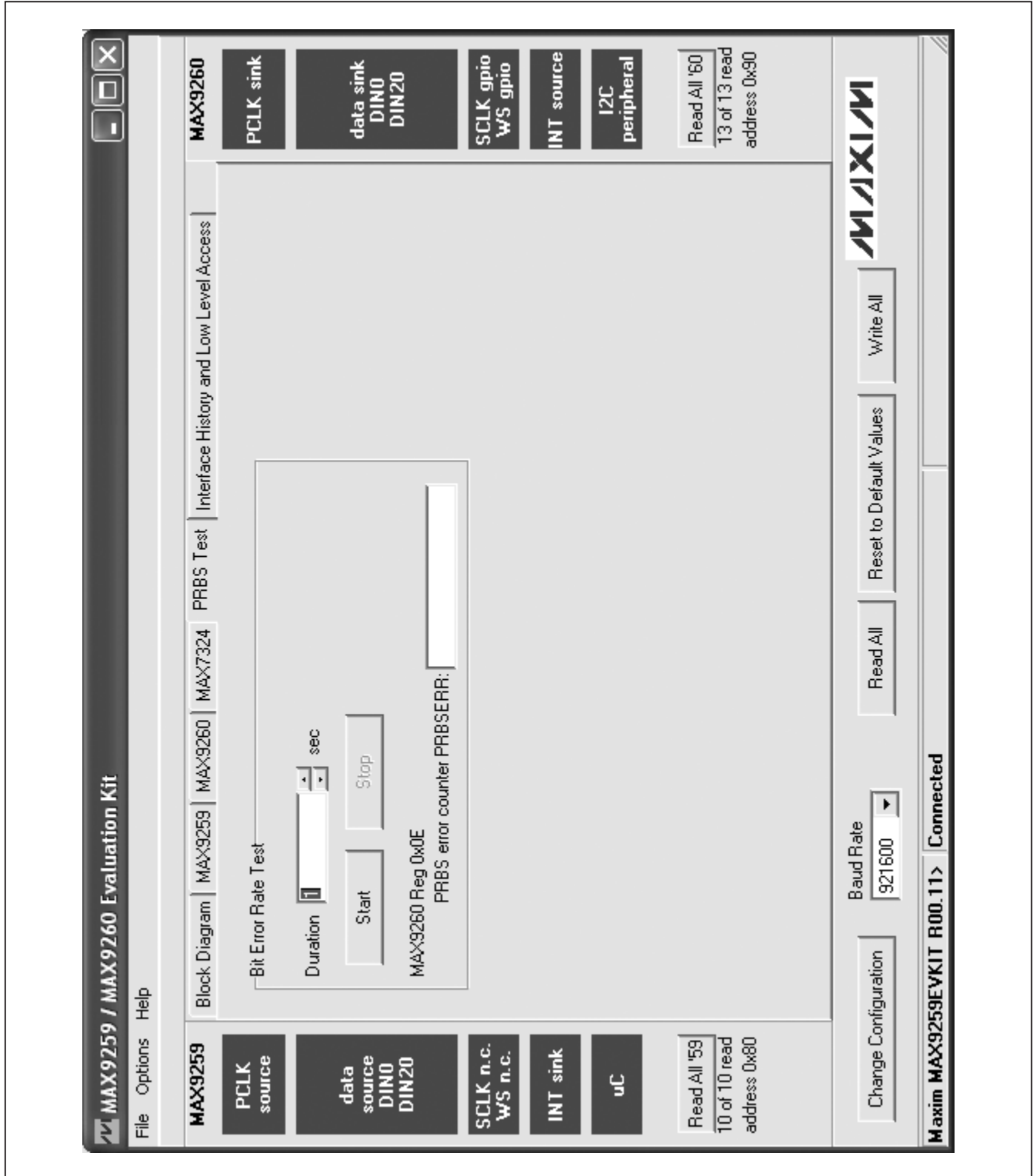

Figure 5. MAX9259/MAX9260 EV Kit Software Main Window (PRBS Test Tab)

MAX9259 Evaluation Kit

Evaluates: **MAX9259**

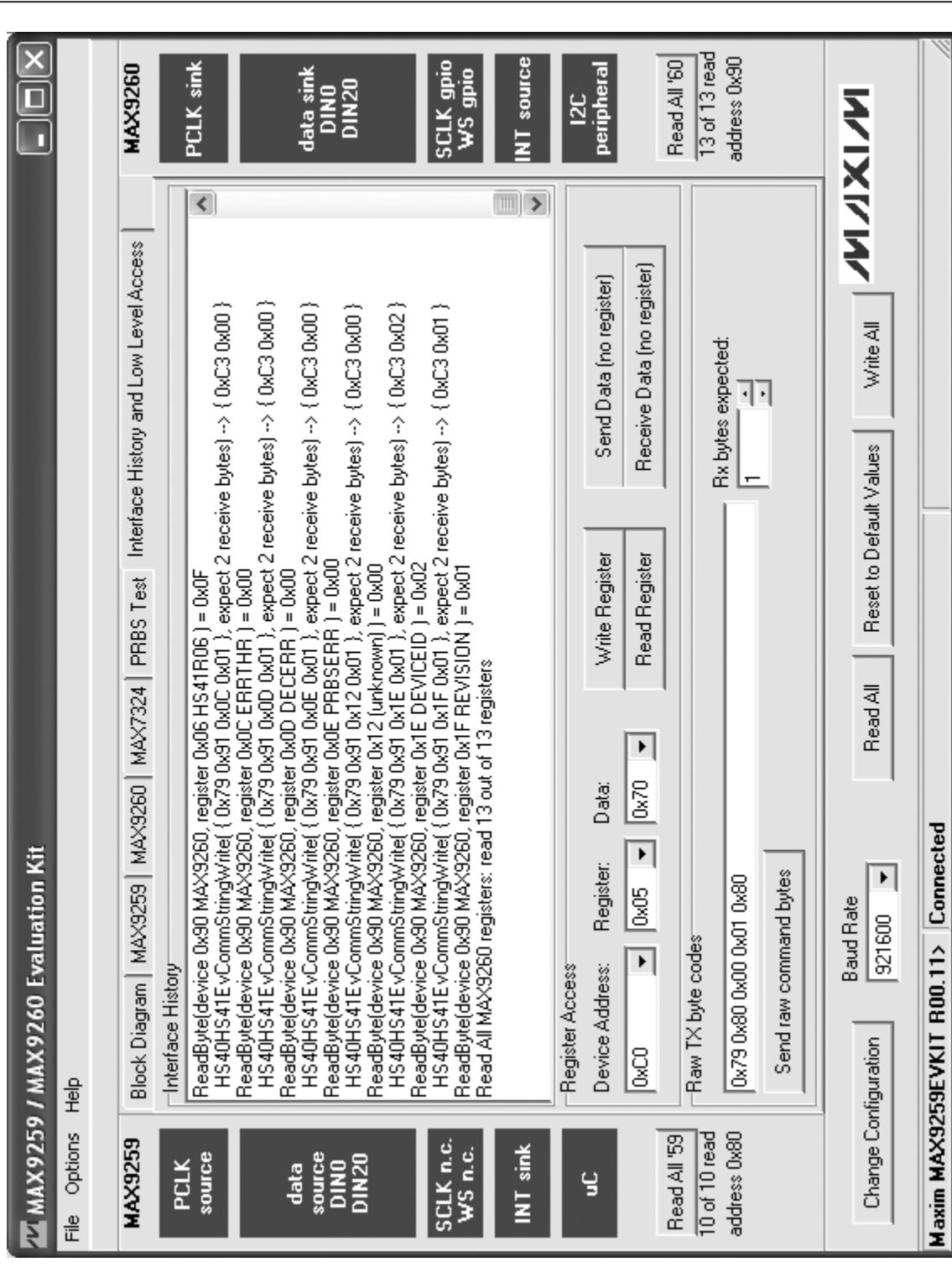

Figure 6. MAX9259/MAX9260 EV Kit Software Main Window (Interface History and Low Level Access Tab)

MAX9259 Evaluation Kit

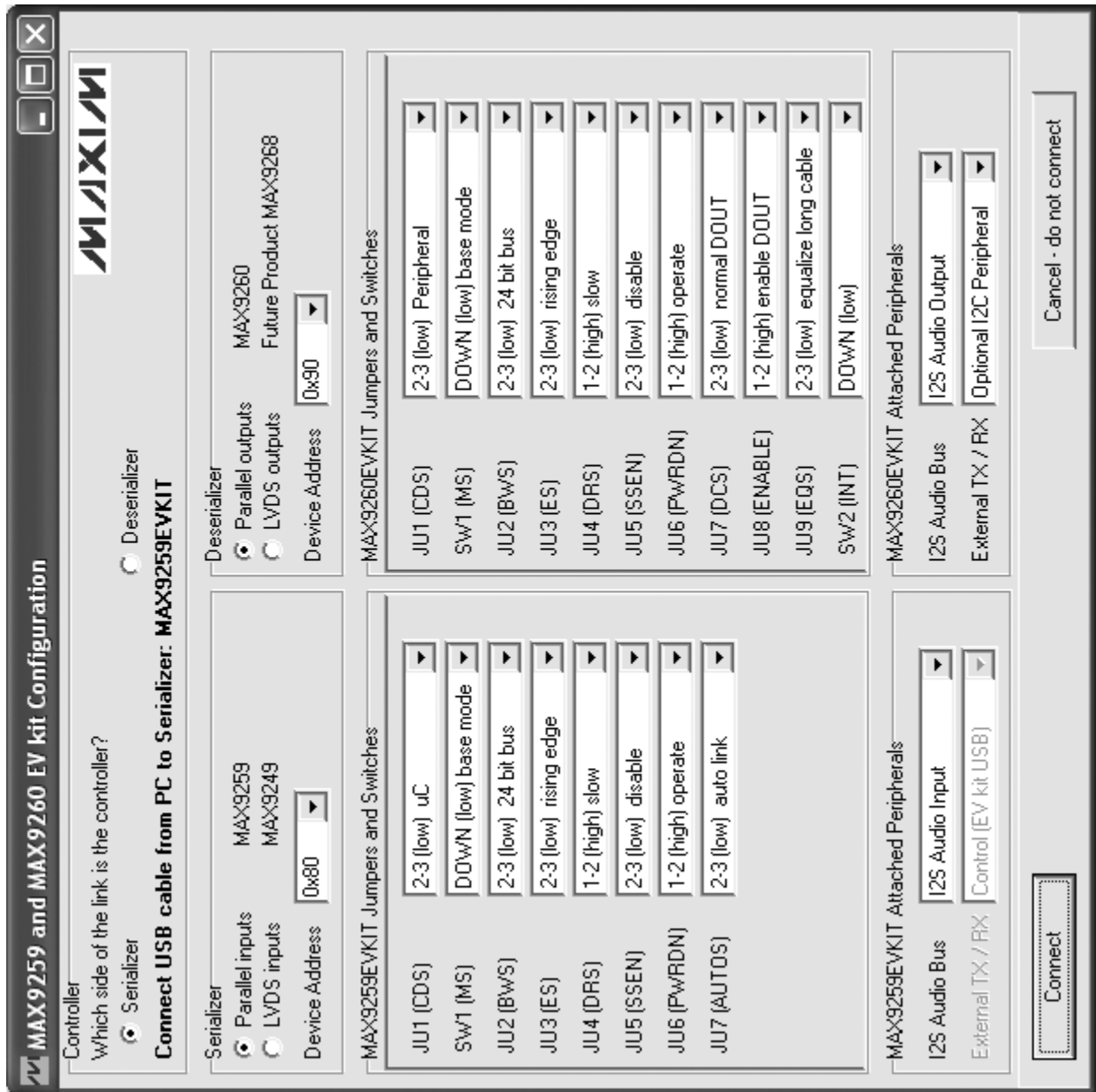

Figure 7. MAX9259/MAX9260 EV Kit Software Configuration Window

MAX9259 Evaluation Kit

Evaluates: MAX9259

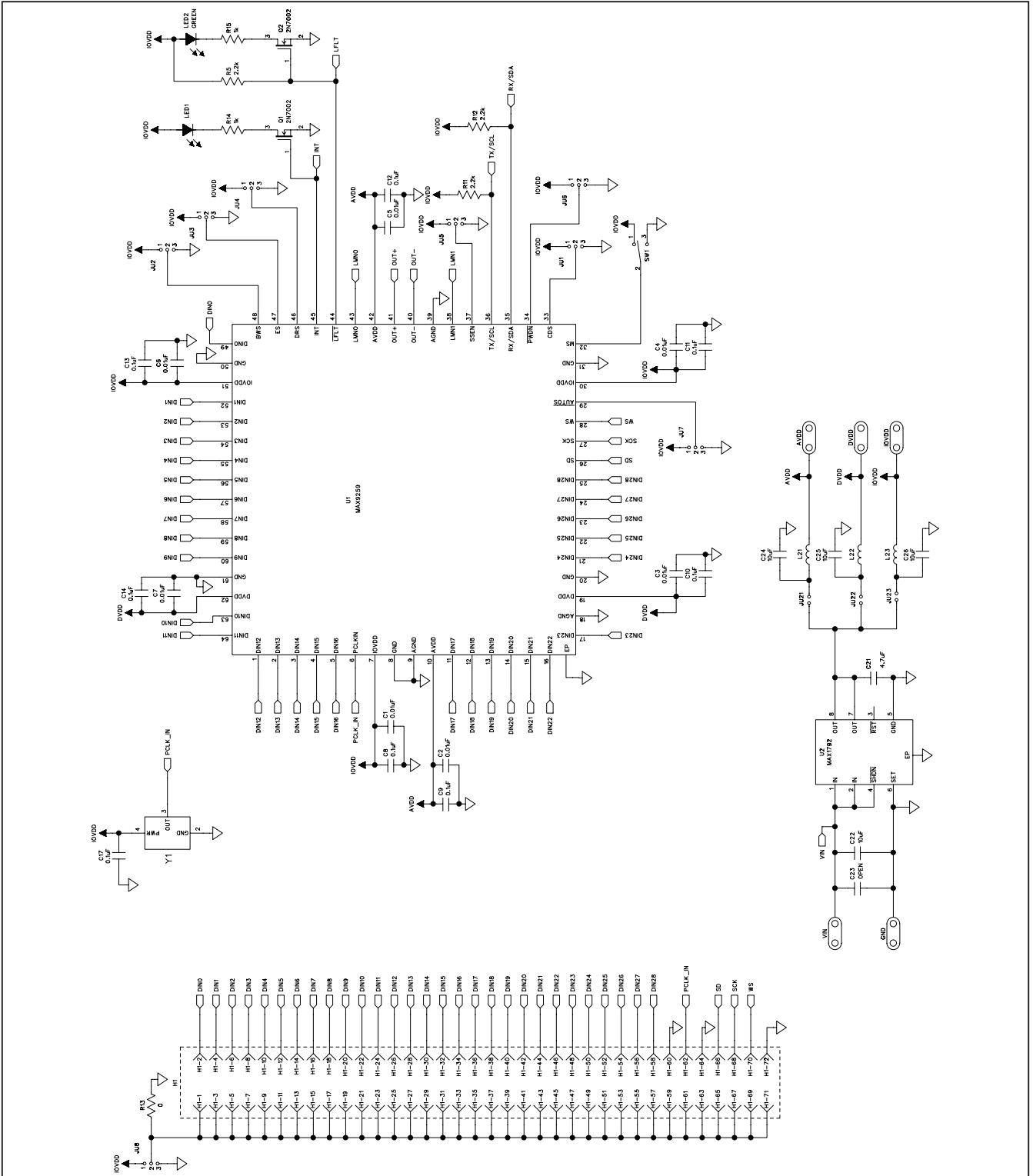

Figure 8a. MAX9259 EV Kit Schematic (Sheet 1 of 4)

MAX9259 Evaluation Kit

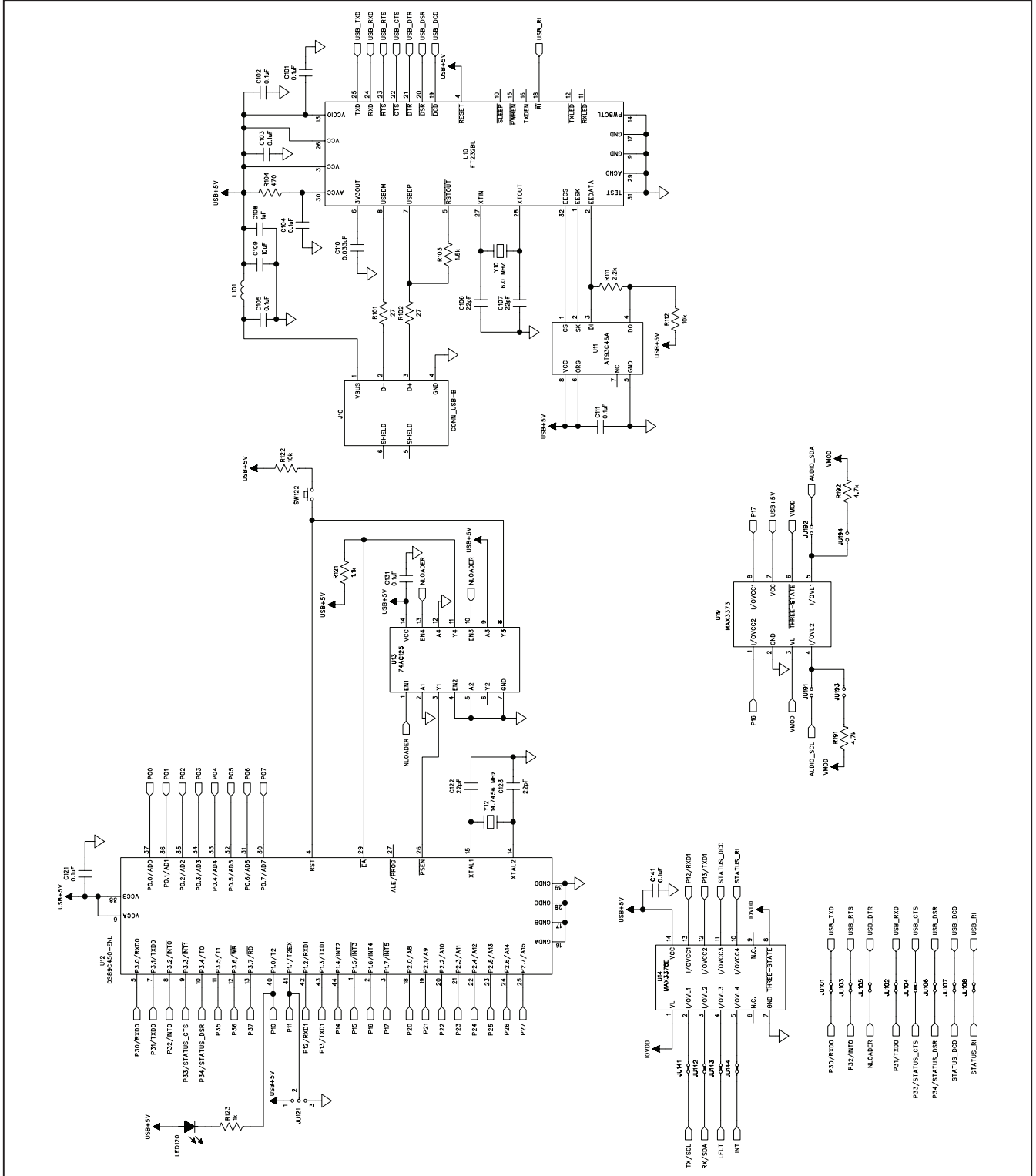

Figure 8b. MAX9259 EV Kit Schematic (Sheet 2 of 4)

MAX9259 Evaluation Kit

Evaluates: MAX9259

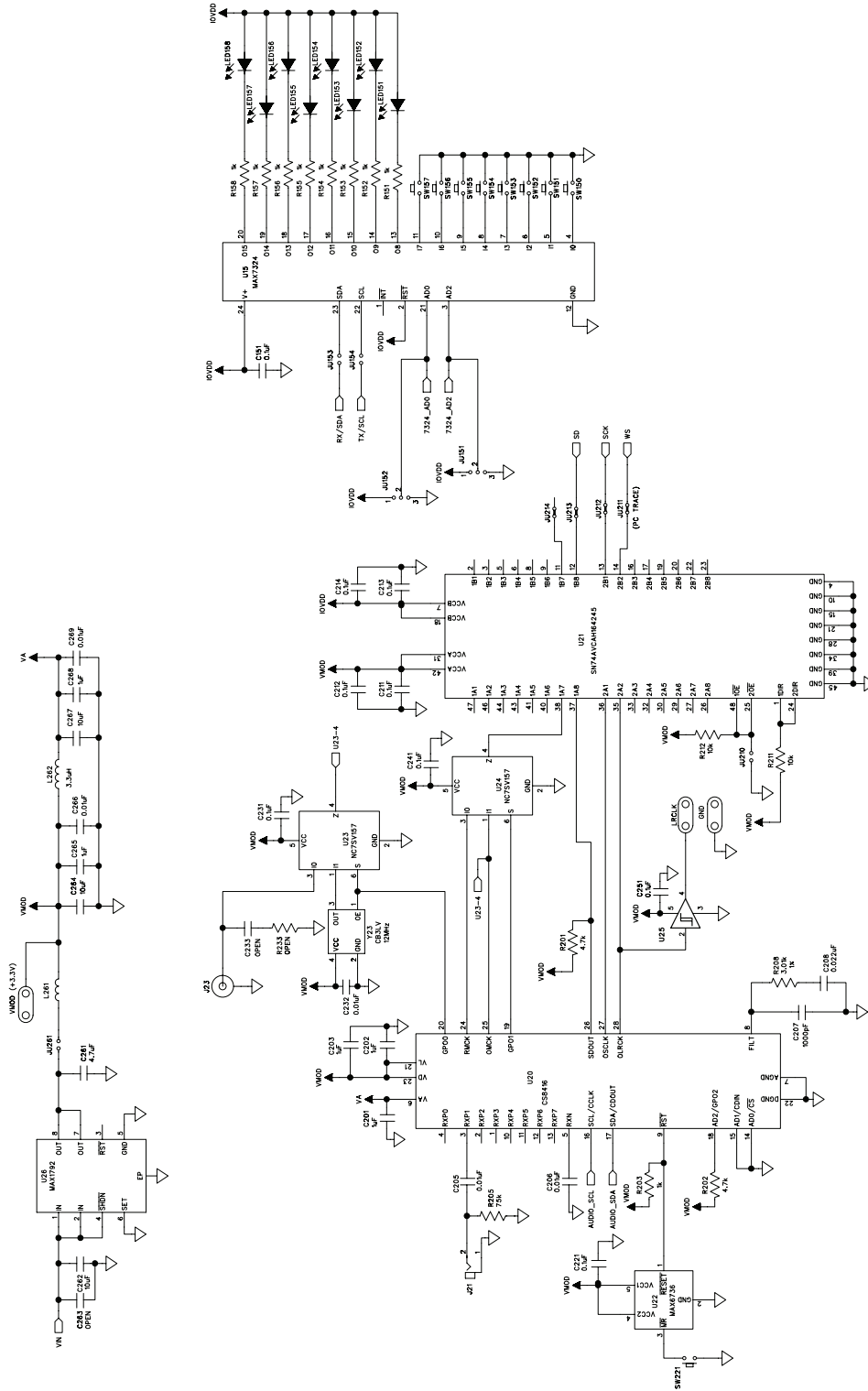

Figure 8c. MAX9259 EV Kit Schematic (Sheet 3 of 4)

MAX9259 Evaluation Kit

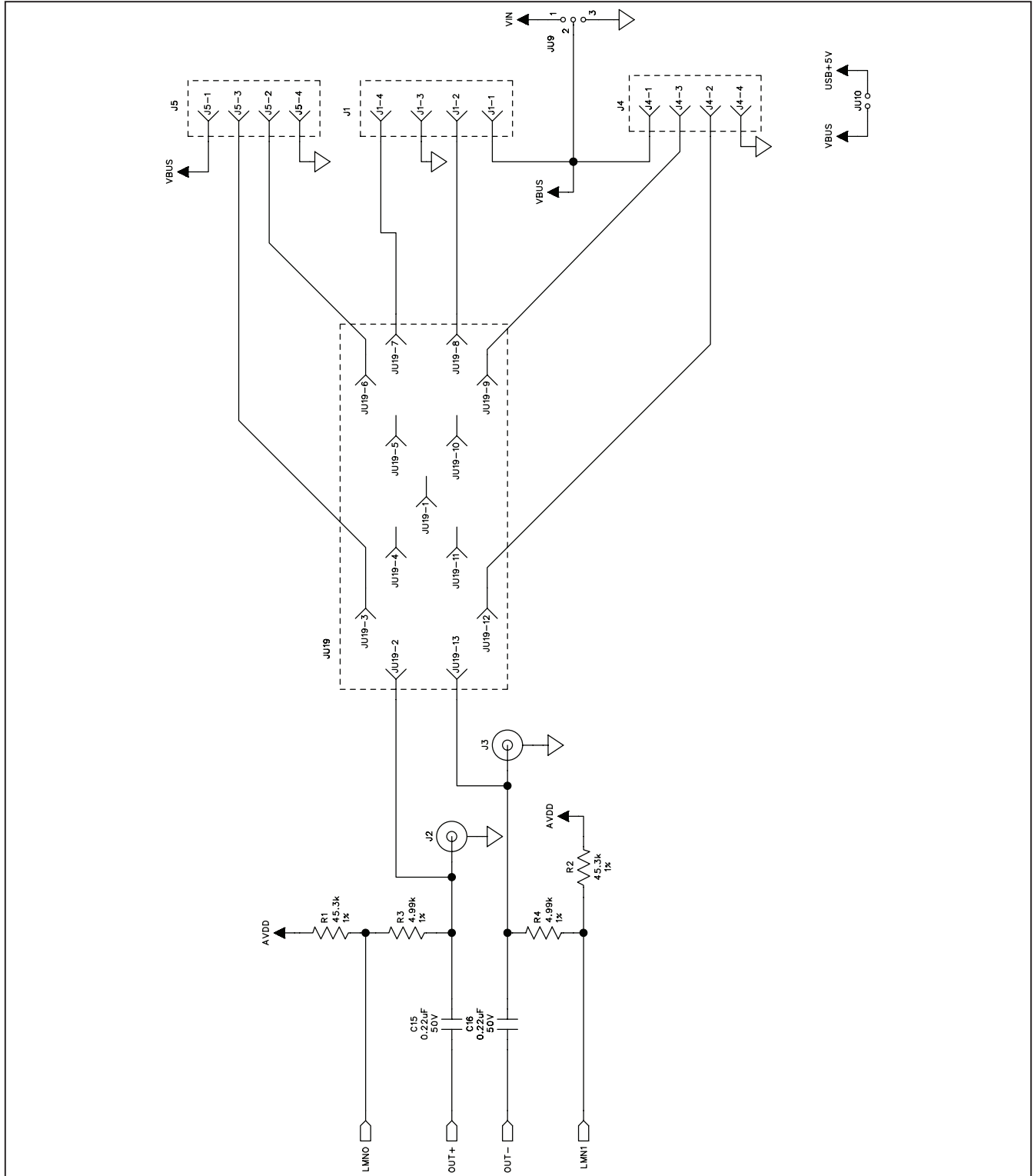

Figure 8d. MAX9259 EV Kit Schematic (Sheet 4 of 4)

MAX9259 Evaluation Kit

Evaluates: **MAX9259**

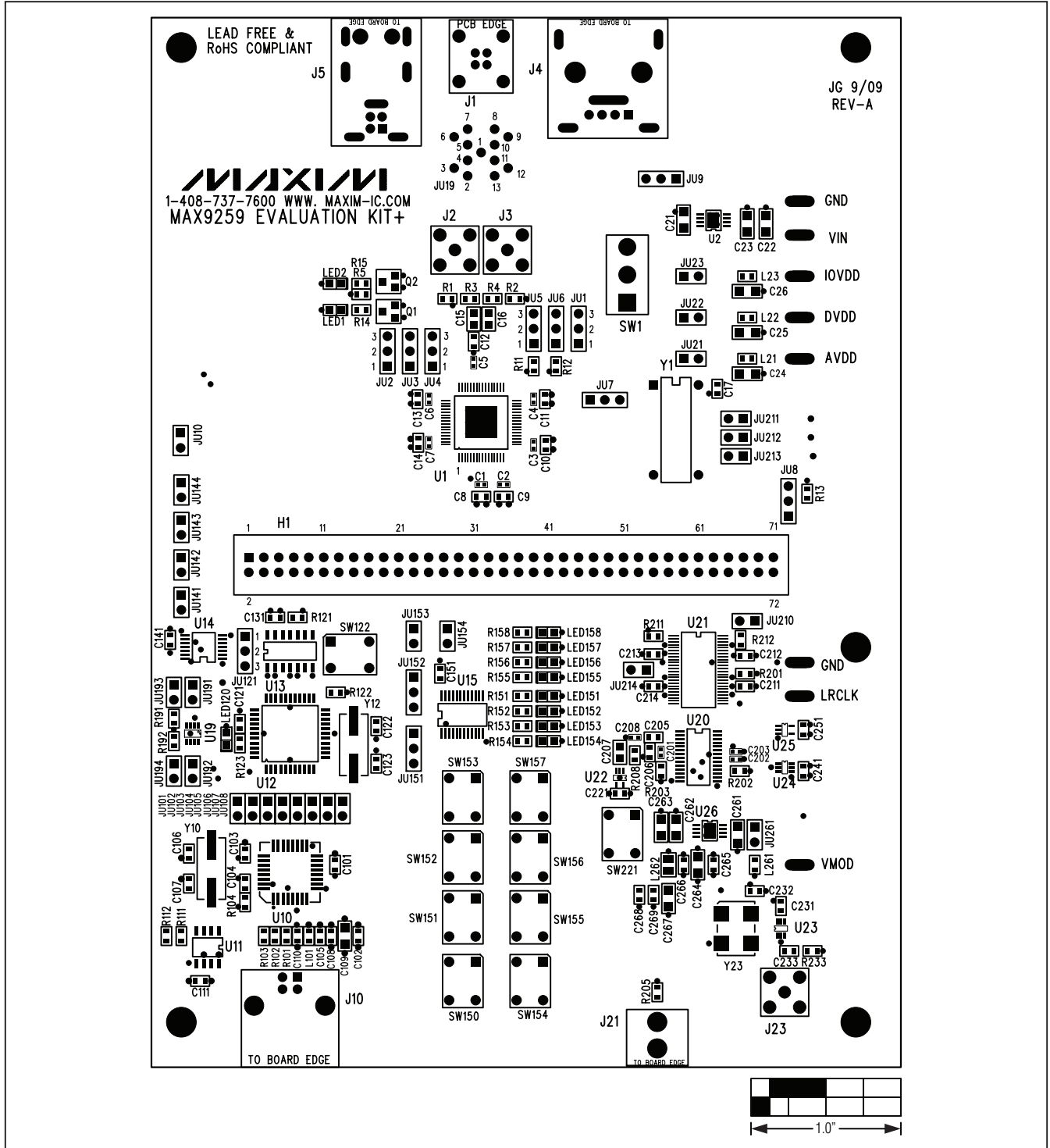

Figure 9. MAX9259 EV Kit Component Placement Guide—Component Side

MAX9259 Evaluation Kit

Evaluates: MAX9259

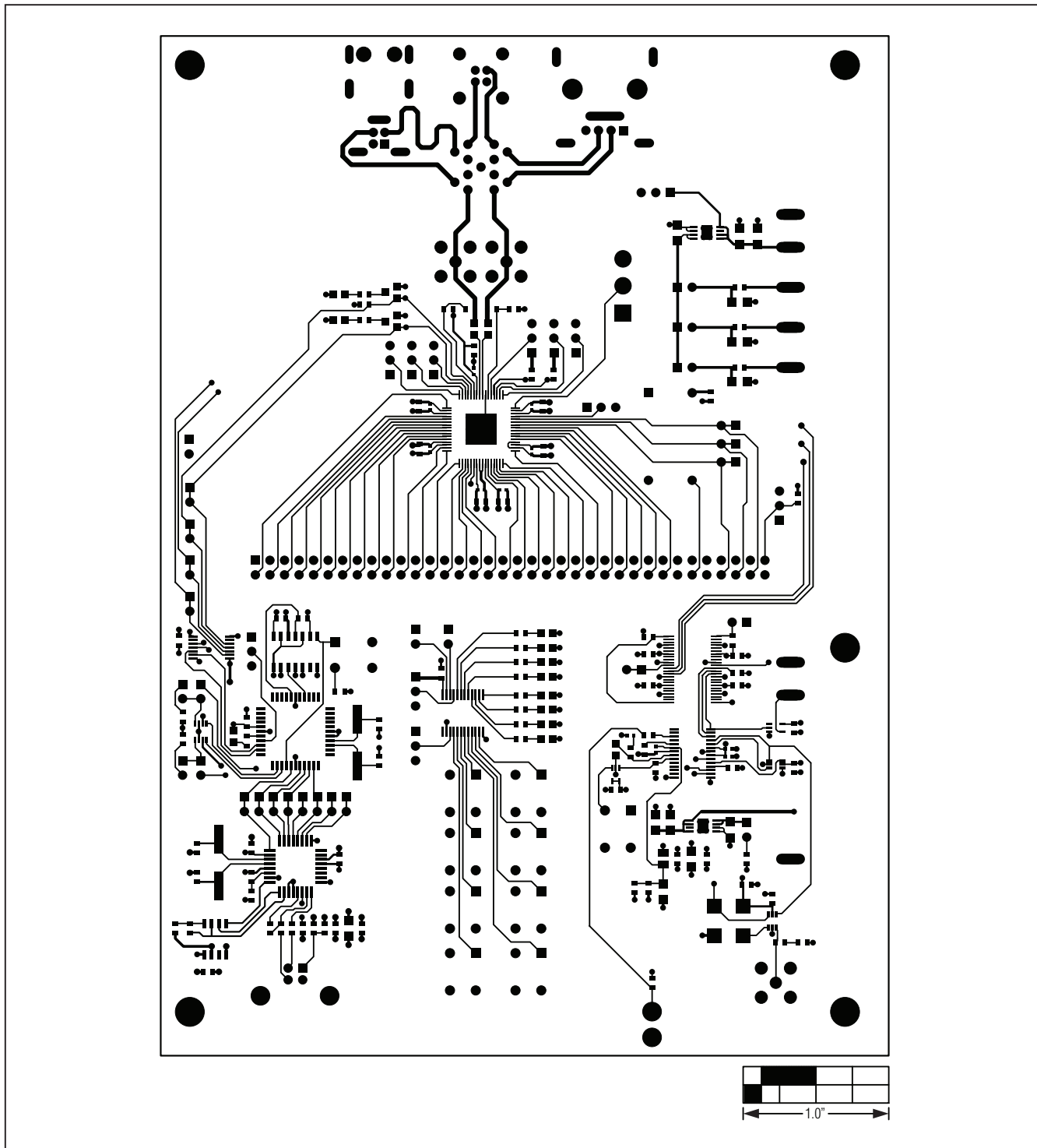

Figure 10. MAX9259 EV Kit PCB Layout—Component Side

MAX9259 Evaluation Kit

Evaluates: MAX9259

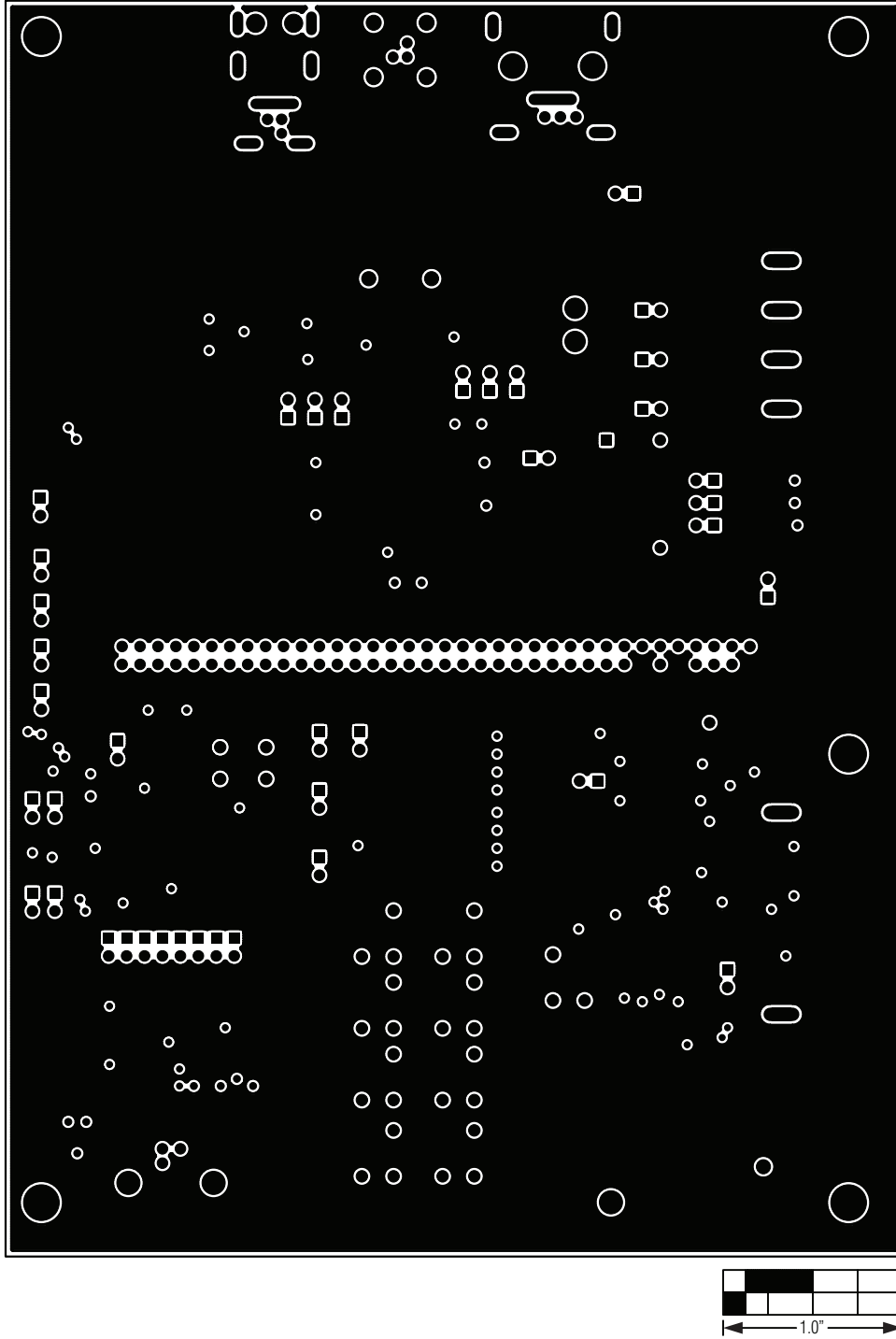

Figure 11. MAX9259 EV Kit PCB Layout—Ground Layer 2

MAX9259 Evaluation Kit

Evaluates: MAX9259

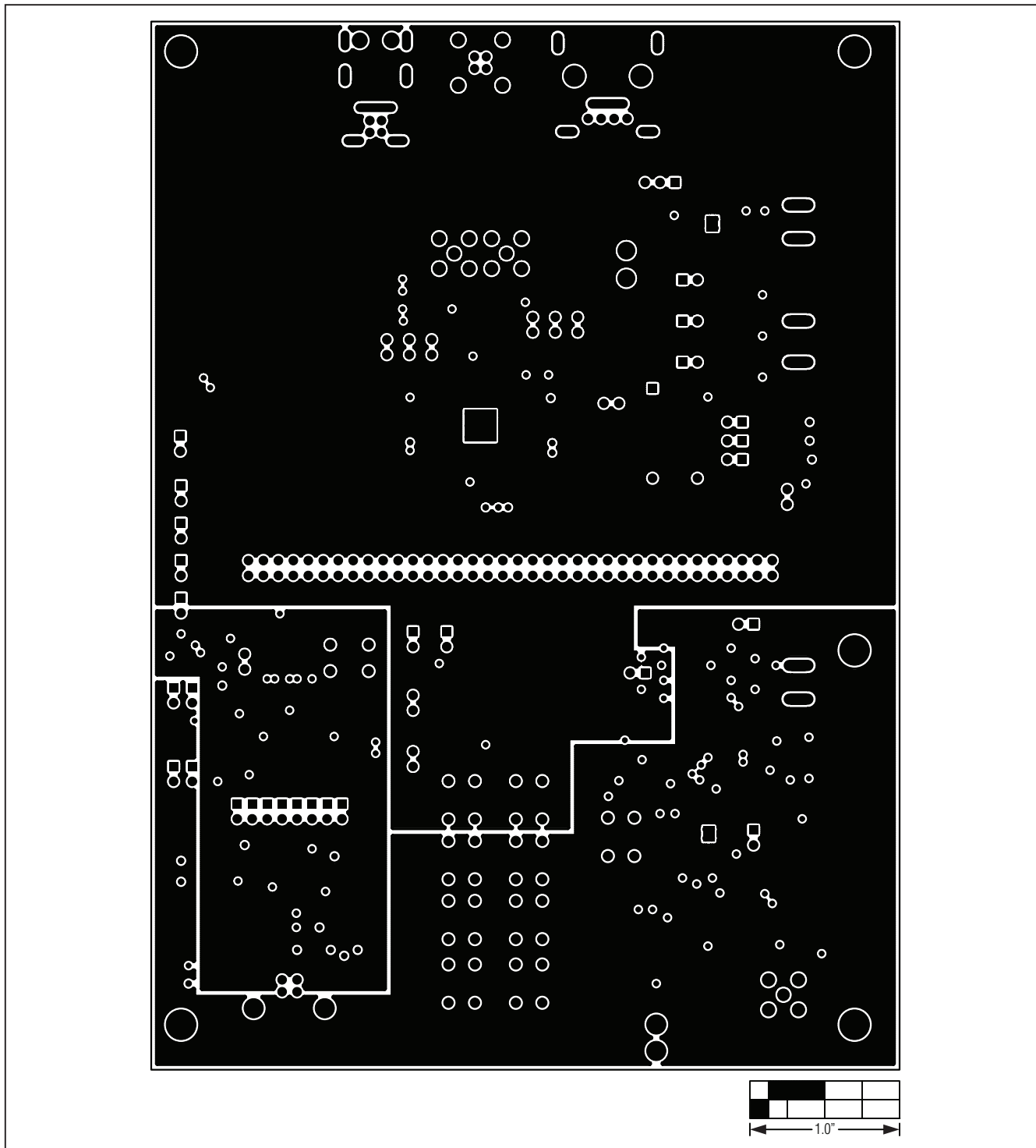

Figure 12. MAX9259 EV Kit PCB Layout—Power Layer 3

MAX9259 Evaluation Kit

Evaluates: MAX9259

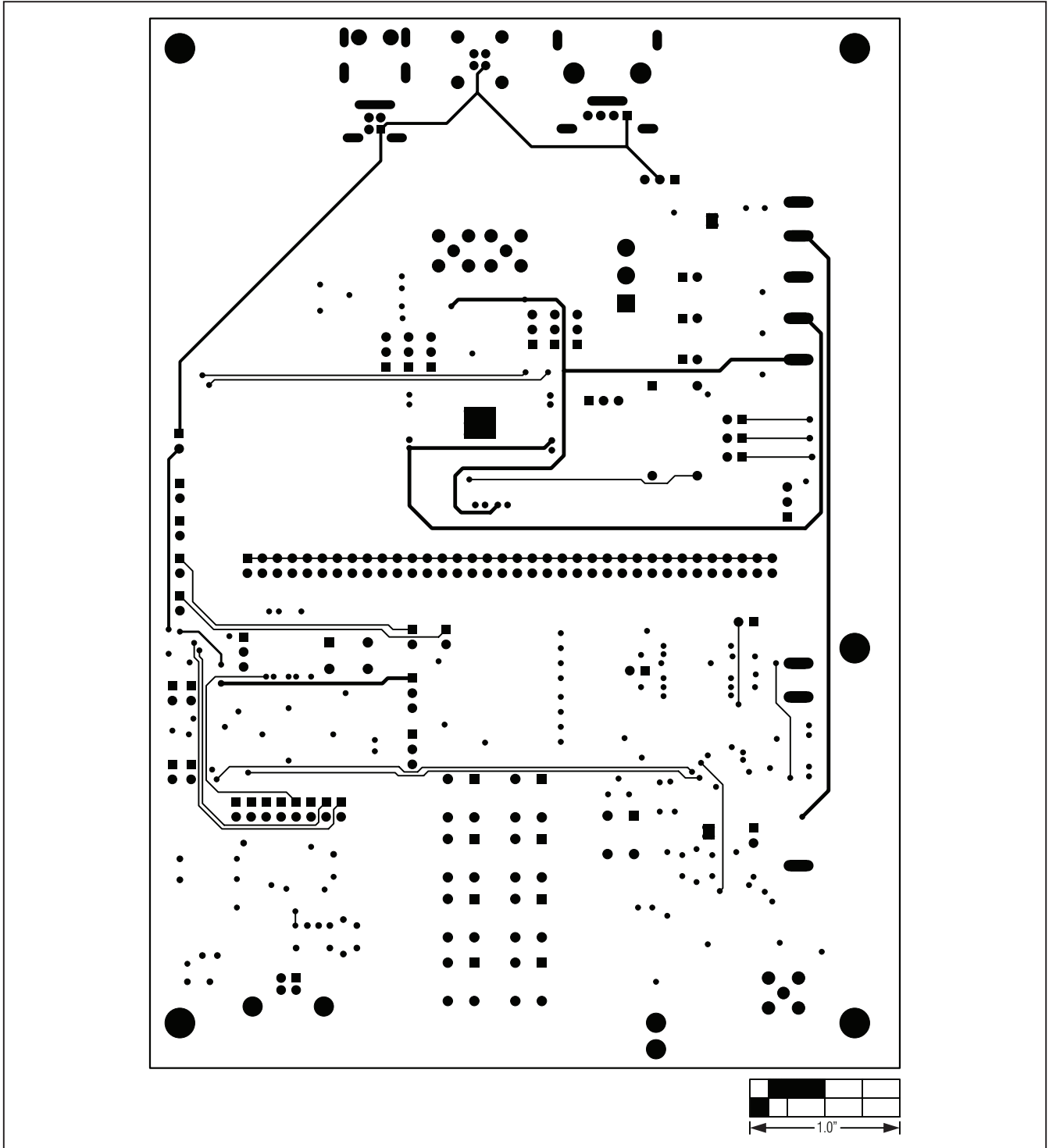

Figure 13. MAX9259 EV Kit PCB Layout—Solder Side

MAX9259 Evaluation Kit

Evaluates: MAX9259

Revision History

REVISION NUMBER	REVISION DATE	DESCRIPTION	PAGES CHANGED
0	10/09	Initial release	—
1	4/10	Updated jumper JU10 in Table 1	7

Maxim cannot assume responsibility for use of any circuitry other than circuitry entirely embodied in a Maxim product. No circuit patent licenses are implied. Maxim reserves the right to change the circuitry and specifications without notice at any time.

26 **Maxim Integrated Products, 120 San Gabriel Drive, Sunnyvale, CA 94086 408-737-7600**

© 2010 Maxim Integrated Products

Maxim is a registered trademark of Maxim Integrated Products, Inc.