

SECTION A-A  
(WITHOUT CAP)

SECTION A-A  
(WITH CAP)

NOTES:

- MATERIAL:  
HOUSING: NYLON, GLASS FILLED, UL94 V-0,  
COLOR - SEE TABLE.  
CAP: NYLON, GLASS FILLED, UL94V-0  
COLOR: BEIGE.  
PINS: BRASS ALLOY, C26000, P/N87437-8083.
- PLATING: 2.54µM. MIN. TIN OVER 1.27µM MIN. NICKEL.
- DRAWING SHOWS PLUG WITH 5 CIRCUITS.
- HEADER TO BE USED WITH CRIMP HOUSING, P/N 87439  
AND CRIMP TERMINAL, P/N 87421.
- PARTS TO BE PACKED IN MOISTURE BAG.

ADD MOIST BAG NOTE EC NO: S2007-1049 DRWNS:KANG CHKD:ATSEE APPR:MLONG	2007/06/22	DESCRIPTION REV
	2007/06/22	
	2007/06/22	
	2007/06/22	
D7		

QUALITY SYMBOLS	▽=0
	∇=0

GENERAL TOLERANCES (UNLESS SPECIFIED)	
mm	INCH
4 PLACES ± ---	± ---
3 PLACES ± ---	± ---
2 PLACES ± 0.20	± ---
1 PLACE ± ---	± ---
ANGULAR ± 3°	
DRAFT WHERE APPLICABLE MUST REMAIN WITHIN DIMENSIONS	

DIMENSION STYLE	
MM ONLY	
DRAWN BY	DATE
KCLING	1994/04/08
CHECKED BY	DATE
SKTOH	1994/04/21
APPROVED BY	DATE
RWONG	1994/04/21
MATERIAL NO.	
SEE TABLE	
SIZE	A3

SCALE	NTS	DESIGN UNITS	METRIC	THIRD ANGLE PROJECTION
1.50MM PITCH, W-T-B HEADER, VERTICAL, SMT				
MOLEX INCORPORATED				
DOCUMENT NO.			SHEET NO.	
SD-87437-***31			1 OF 4	
THIS DRAWING CONTAINS INFORMATION THAT IS PROPRIETARY TO MOLEX INCORPORATED AND SHOULD NOT BE USED WITHOUT WRITTEN PERMISSION				

10 9 8 7 6 5 4 3 2 1

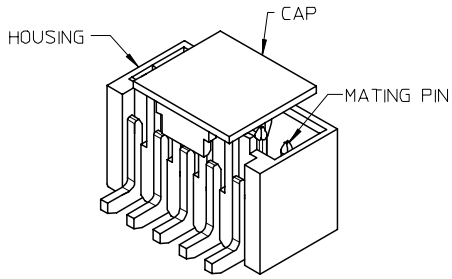

PART NUMBER ASSIGNMENT

87437-XXXX

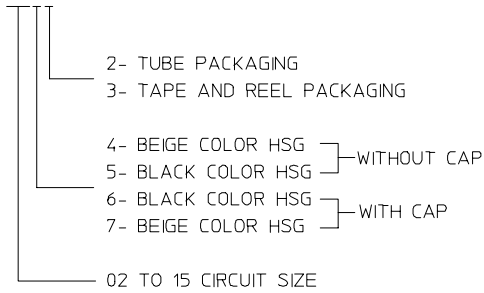

CIRCUIT SIZE	A	B	C	D	E
02	1.50	3.30	3.70	4.30	1.70
03	3.00	4.80	5.20	5.80	3.20
04	4.50	6.30	6.70	7.30	4.70
05	6.00	7.80	8.20	8.80	6.20
06	7.50	9.30	9.70	10.30	7.70
07	9.00	10.80	11.20	11.80	9.20
08	10.50	12.30	12.70	13.30	10.70
09	12.00	13.80	14.20	14.80	12.20
10	13.50	15.30	15.70	16.30	13.70
11	15.00	16.80	17.20	17.80	15.20
12	16.50	18.30	18.70	19.30	16.70
13	18.00	19.80	20.20	20.80	18.20
14	19.50	21.30	21.70	22.30	19.70
15	21.00	22.80	23.20	23.80	21.20

F  
E  
D  
C  
B  
A

F  
E  
D  
C  
B  
A

ADD MOIST BAG NOTE EC NO: S2007-1049 DRWN:SKANG CHKD:ATSEE APPR:MLONG	2007/06/22 2007/06/22 2007/06/22	DESCRIPTION REV	QUALITY SYMBOLS ▽=0 ▽=0	GENERAL TOLERANCES (UNLESS SPECIFIED) <table border="1"> <thead> <tr> <th></th> <th>mm</th> <th>INCH</th> </tr> </thead> <tbody> <tr><td>4 PLACES</td><td>± ---</td><td>± ---</td></tr> <tr><td>3 PLACES</td><td>± ---</td><td>± ---</td></tr> <tr><td>2 PLACES</td><td>± 0.20</td><td>± ---</td></tr> <tr><td>1 PLACE</td><td>± ---</td><td>± ---</td></tr> </tbody> </table> ANGULAR ± 3°		mm	INCH	4 PLACES	± ---	± ---	3 PLACES	± ---	± ---	2 PLACES	± 0.20	± ---	1 PLACE	± ---	± ---	DIMENSION STYLE MM ONLY DRAWN BY DATE KCL ING 1994/04/08 CHECKED BY DATE SKTOH 1994/04/21 APPROVED BY DATE RWONG 1994/04/21	SCALE NTS DESIGN UNITS METRIC THIRD ANGLE PROJECTION	TITLE 1.50MM PITCH, W-T-B HEADER, VERTICAL, SMT	MOLEX INCORPORATED DOCUMENT NO. SD-87437-**31	SHEET NO. 2 OF 4
				mm	INCH																			
			4 PLACES	± ---	± ---																			
			3 PLACES	± ---	± ---																			
2 PLACES	± 0.20	± ---																						
1 PLACE	± ---	± ---																						
DRAFT WHERE APPLICABLE MUST REMAIN WITHIN DIMENSIONS				SEE TABLE	THIS DRAWING CONTAINS INFORMATION THAT IS PROPRIETARY TO MOLEX INCORPORATED AND SHOULD NOT BE USED WITHOUT WRITTEN PERMISSION																			
SIZE A3																								
D7																								

9 8 7 6 5 4 3 2 1

10 9 8 7 6 5 4 3 2 1

EMBOSSED CARRIER TAPE PACKING DETAILS FOR PARTS WITHOUT CAP

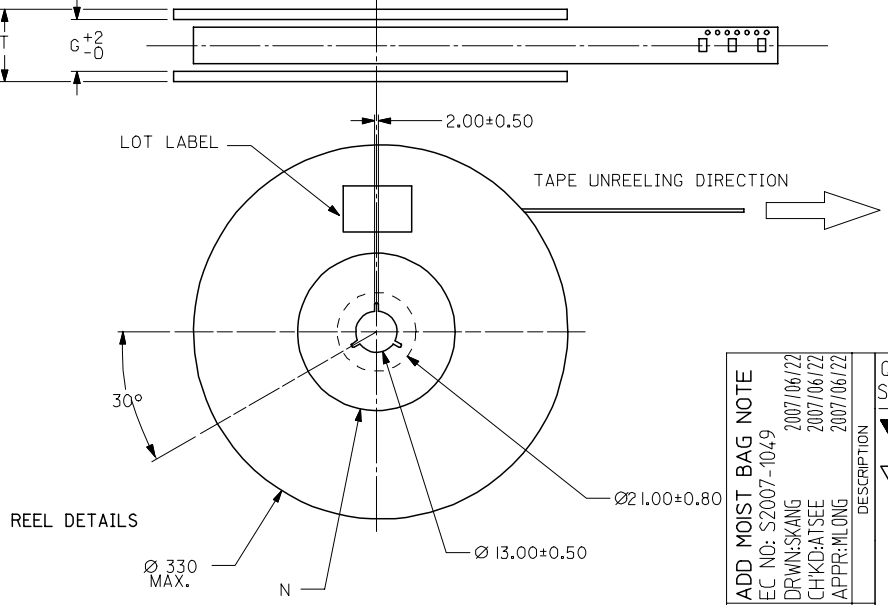
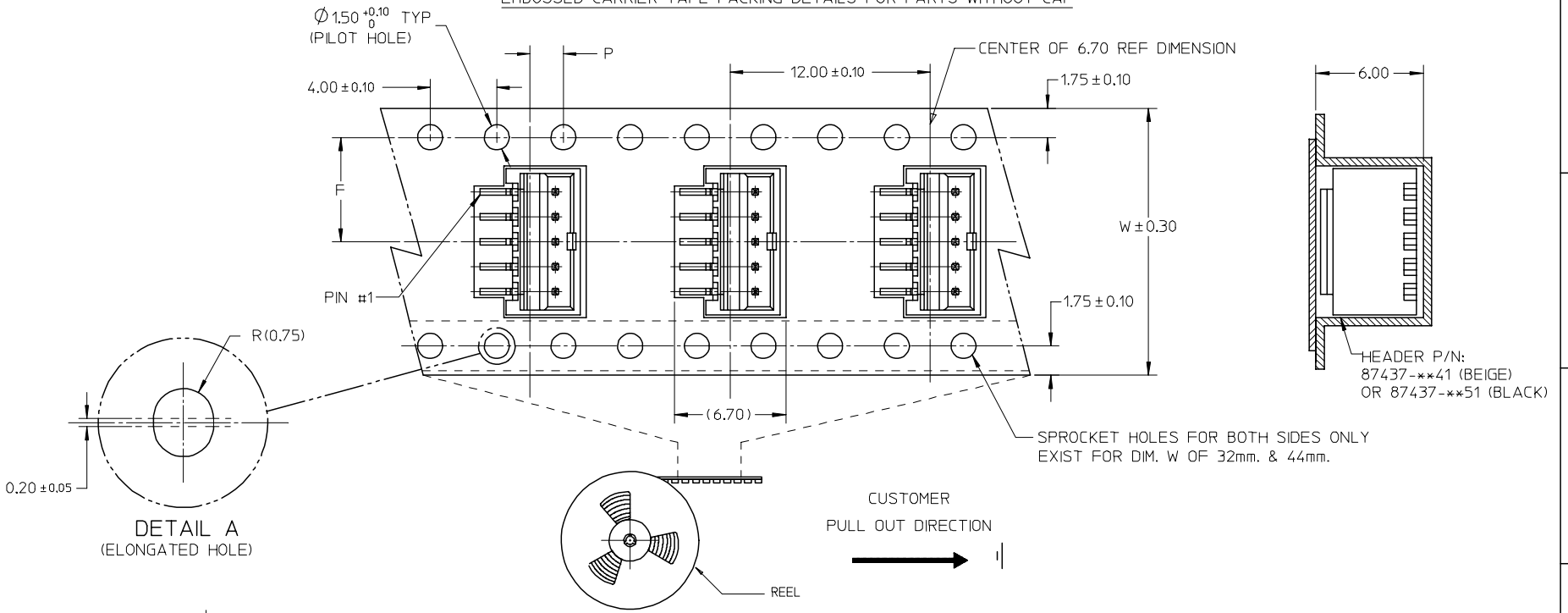

ADD MOIST BAG NOTE	DESCRIPTION
EC NO: S2007-1049	REV
DRWN:SKANG	D7
CHKD:ATSEE	
APPR:MLONG	
2007/06/22	
2007/06/22	
2007/06/22	

QUALITY SYMBOLS	DESCRIPTION
▽=0	
▽C=0	

GENERAL TOLERANCES (UNLESS SPECIFIED)	DIMENSION STYLE	
	MM ONLY	
	mm	INCH
4 PLACES	± ---	± ---
3 PLACES	± ---	± ---
2 PLACES	± 0.20	± ---
1 PLACE	± ---	± ---
ANGULAR ± 3 °		
DRAFT WHERE APPLICABLE MUST REMAIN WITHIN DIMENSIONS		

DRAWN BY	DATE	TITLE
KCLING	1994/04/08	1.50MM PITCH, W-T-B HEADER, VERTICAL, SMT
CHECKED BY	DATE	
SKTOH	1994/04/21	
APPROVED BY	DATE	
RWONG	1994/04/21	
MATERIAL NO.		DOCUMENT NO.
SEE TABLE		SD-87437-***31
SIZE	THIS DRAWING CONTAINS INFORMATION THAT IS PROPRIETARY TO MOLEX INCORPORATED AND SHOULD NOT BE USED WITHOUT WRITTEN PERMISSION	
A3		

SCALE	DESIGN UNITS	THIRD ANGLE PROJECTION
NTS	METRIC	
MOLEX INCORPORATED		
DOCUMENT NO.		SHEET NO.
SD-87437-***31		3 OF 4

9 8 7 6 5 4 3 2 1

EMBOSSED CARRIER TAPE PACKING DETAILS FOR PARTS WITH CAP

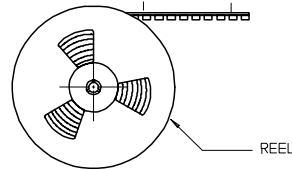
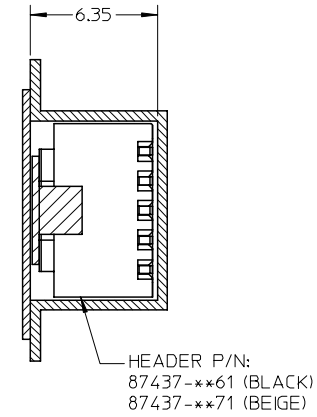
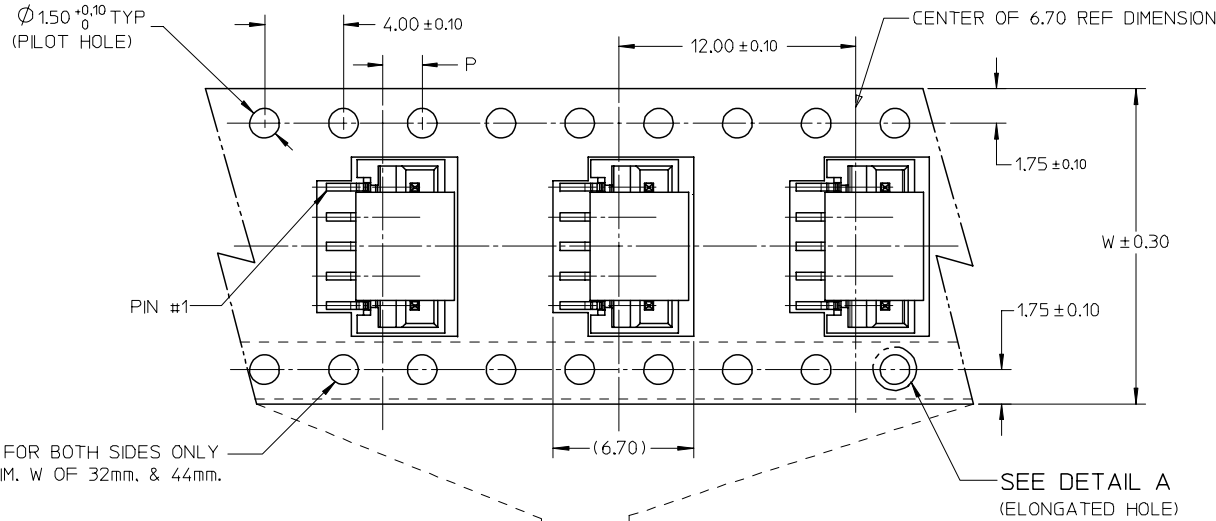

NOTES:

1. LEADER AND TRAILER TAPE

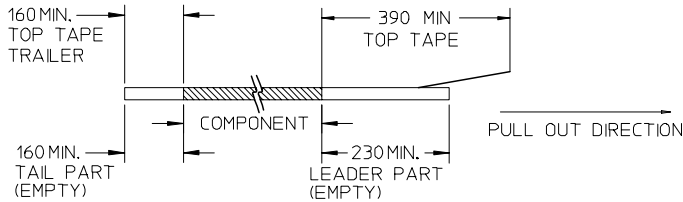

2. PEELING OFF FORCE OF THE TOP TAPE: 20-80gf. (PEELING DIRECTION AS SHOWN IN FOLLOWING FIGURE)

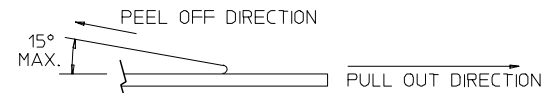

- 3. THE TAPE IS TREATED FOR ANTI-STATIC.
- 4. PACKAGING STANDARD IS AS PER EIA-481.
- 5. TAPE & REEL QUANTITY = 1000PCS/REEL (WITHOUT CAP)  
TAPE & REEL QUANTITY = 900PCS/REEL (WITH CAP)

15	44	20.20±0.15	100	44.40	50.40	2.00±0.15
11, 12, 13, 14	32	14.20±0.10	100	32.40	38.40	2.00±0.10
7, 8, 9, 10	24	11.50±0.10	100	24.40	30.40	2.00±0.10
2, 3, 4, 5, 6	16	7.50±0.10	100	16.40	22.40	2.00±0.10
CIRCUIT SIZE	W	F	N	G	T MAX	P

ADD MOIST BAG NOTE EC NO: S2007-1049 DRWNS:KANG CHKD:ATSEE APPR:MLONG	2007/06/22 2007/06/22 2007/06/22	QUALITY SYMBOLS ▽=0 ▽=0	GENERAL TOLERANCES (UNLESS SPECIFIED)		DIMENSION STYLE MM ONLY		SCALE NTS	DESIGN UNITS METRIC	THIRD ANGLE PROJECTION	
					DRAWN BY DATE KCLING 1994/04/08		TITLE 1.50MM PITCH, W-T-B HEADER, VERTICAL, SMT			
					CHECKED BY DATE SKTOH 1994/04/21		APPROVED BY DATE RWONG 1994/04/21			
					1 PLACE ± --- ± --- ANGULAR ± 3 °		MATERIAL NO.		DOCUMENT NO. SD-87437-**-31	
DRAFT WHERE APPLICABLE MUST REMAIN WITHIN DIMENSIONS			SIZE A3		THIS DRAWING CONTAINS INFORMATION THAT IS PROPRIETARY TO MOLEX INCORPORATED AND SHOULD NOT BE USED WITHOUT WRITTEN PERMISSION					