

Features

- High sensitivity magnetic sensor making use of the magnetic impedance effect.
- The usability has been remarkably improved by reducing the variation in the detection performance.

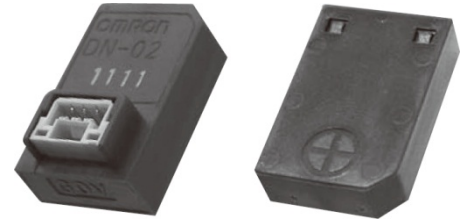

Type code standard

- Type W2DN - 02 A
- (1) Represents a wide area magnetic sensor
 - (2) Represents a series name
 - (3) Represents a sensitivity rank

Specifications

Item	Rating / performance	
Detection range: Rx, Ry (*1)	Type (sensitivity rank)	W2DN-02A
	max.	155 mm
	typ.	145 mm
	min.	135 mm
Standard magnet	Exterior dimensions of the magnet: 20 x 20 x 10 mm Surface magnetic flux density: 430 mT (millitesla) Direction of magnetization: direction of thickness	
Power voltage	5 DCV -10% to 12 DCV +10%	
Power consumption	20 mA or less	
Output states	Open collector output Maximum output current 20 mA or less, output voltage 16 VDC or less	
Output residual voltage	0.5 V or less	
Output operation states	When detected: output transistor OFF When not detected: output transistor ON When faulty (*2): output transistor held OFF	
Response time	0.8 s or less	
Start-up time after powering on (*3)	1.5 s or less	
Ambient temperature (*4)	When in operation: -10 to 60 deg C (must be free from freezing or condensation) When stored: -20 to 70 deg C (must be free from freezing or condensation)	
Ambient humidity	25 to 85 %RH	

*1. The detection range is specified based on the mounting conditions as shown below. (The datum point of the standard magnet is the center of the magnet.)

The specifications are given by Rx and Ry, with Rxy shown for information purpose only.

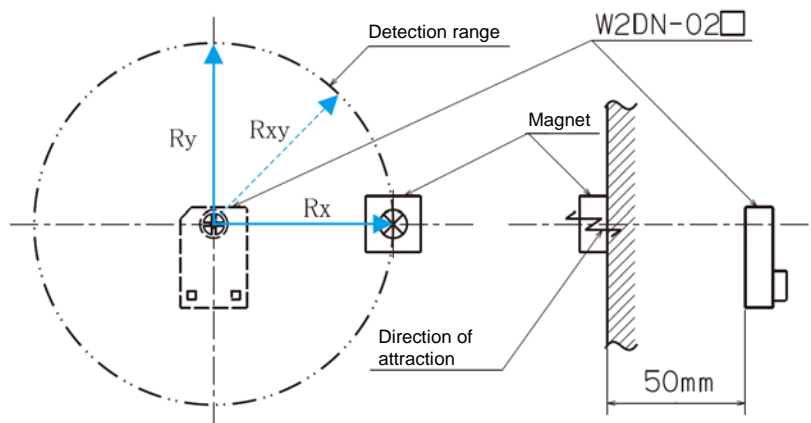

Figure 1 Detection range: R

Figure 2 Mounting conditions

*2. The product has a function to automatically adjust the detection range when the sensor is powering up. This item represents the case of failure to properly conduct the automatic adjustment due to the effects of magnetism in the vicinity of the sensor.

*3. It shows the period of time from the powering ON of the sensor to the correct output of the detected state.

*4. The ambient temperature (when in operation) indicates the temperature range in which the automatic adjustment of the detection range can be properly performed.

Output circuit diagram

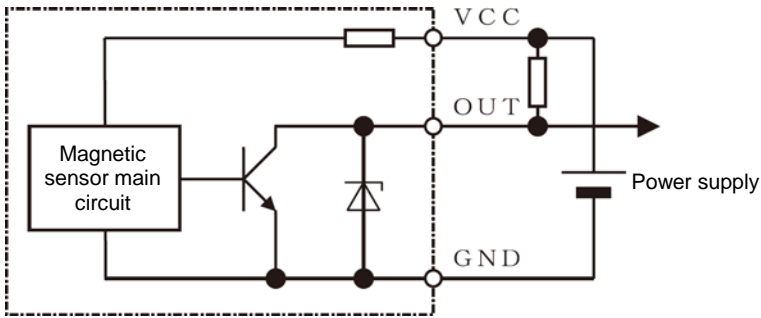

Operation chart

(1) In case the automatic adjustment of the detection range has been properly conducted when powering on the sensor

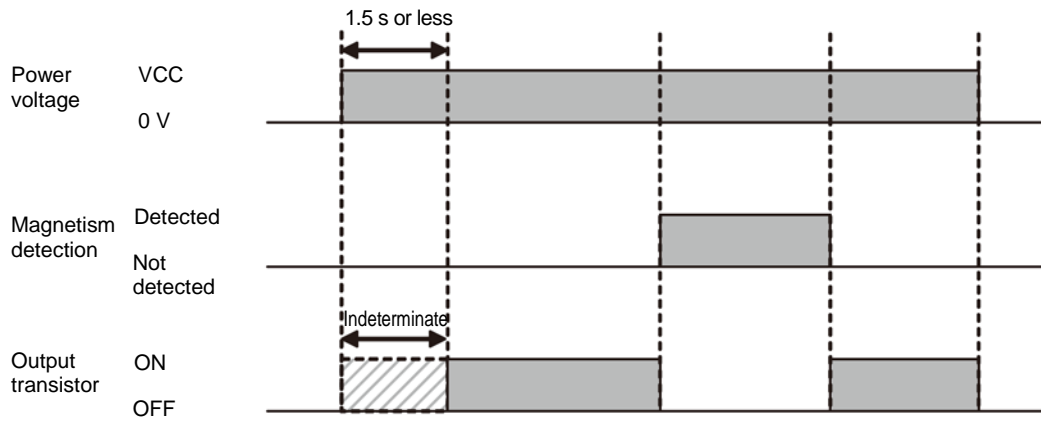

(2) In case the automatic adjustment of the detection range has failed when powering on the sensor

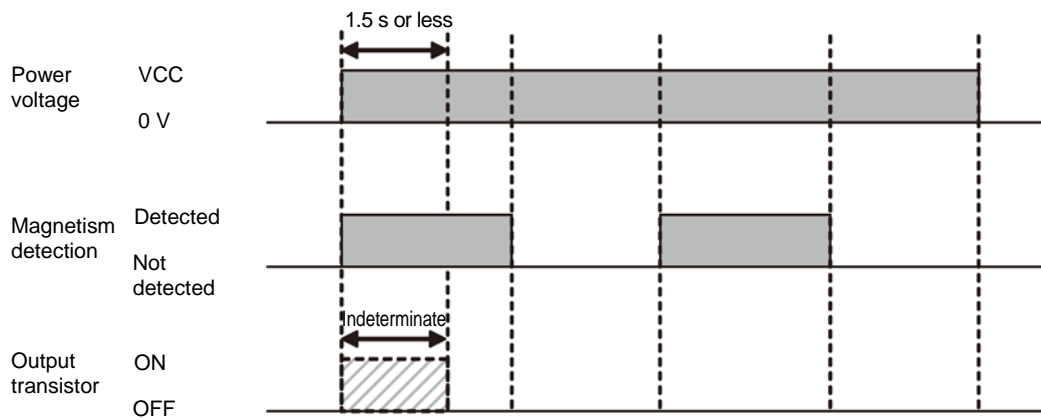

■ Precautions for use

<Sensor actions upon powering ON>

To compensate for the effects of ambient magnetism and temperature, the detection range is automatically adjusted when the sensor is powering ON. When powering ON the sensor, pay attention to the following items.

- (1) For a period of 1.5 seconds after the sensor has been powered ON, the output transistor is forced to stay ON and does not output the detected state.
If the sensor powering ON is extremely slow, the output state of the output transistor may become indeterminate.
- (2) Wherever possible, avoid the effect of magnetism when starting up the sensor. Otherwise, the detection range may fluctuate. When using the sensor, sufficiently check the characteristics.
Examples: Avoid driving solenoids and motors.
Keep magnets away when starting up the sensor.
- (3) If the automatic adjustment has failed when powering ON the sensor due to the effects of magnetism in the vicinity of the sensor, the output transistor is held OFF. To release the state, retry the sensor powering ON with consideration of the effects of magnetism in the vicinity of the sensor so that the automatic adjustment can be properly conducted.

<Effects of metallic objects in the vicinity>

In case any magnetic metal is placed in the vicinity of the sensor, the detection range may become reduced or the automatic adjustment of the detection range may fail, resulting in the output transistor holding the state of being OFF. When using the sensor, sufficiently check the characteristics.

<Effects of magnetic noise>

The sensor may detect the magnetic noises of solenoids, motors, etc.

In that case, incorporate some design considerations, such as keeping the source of the magnetic noise away, or invalidating the sensor output when driving solenoids or motor.

<Precautions on the environmental changes after powering ON>

If the metallic objects around the sensor have been magnetized due to a powerful magnet and, at the same time, the sensor has detected magnetism, the output transistor may keep the state of being OFF. To release the state, the sensor needs to be restarted. Some design considerations should be incorporated to reflect it.

Exterior dimensions

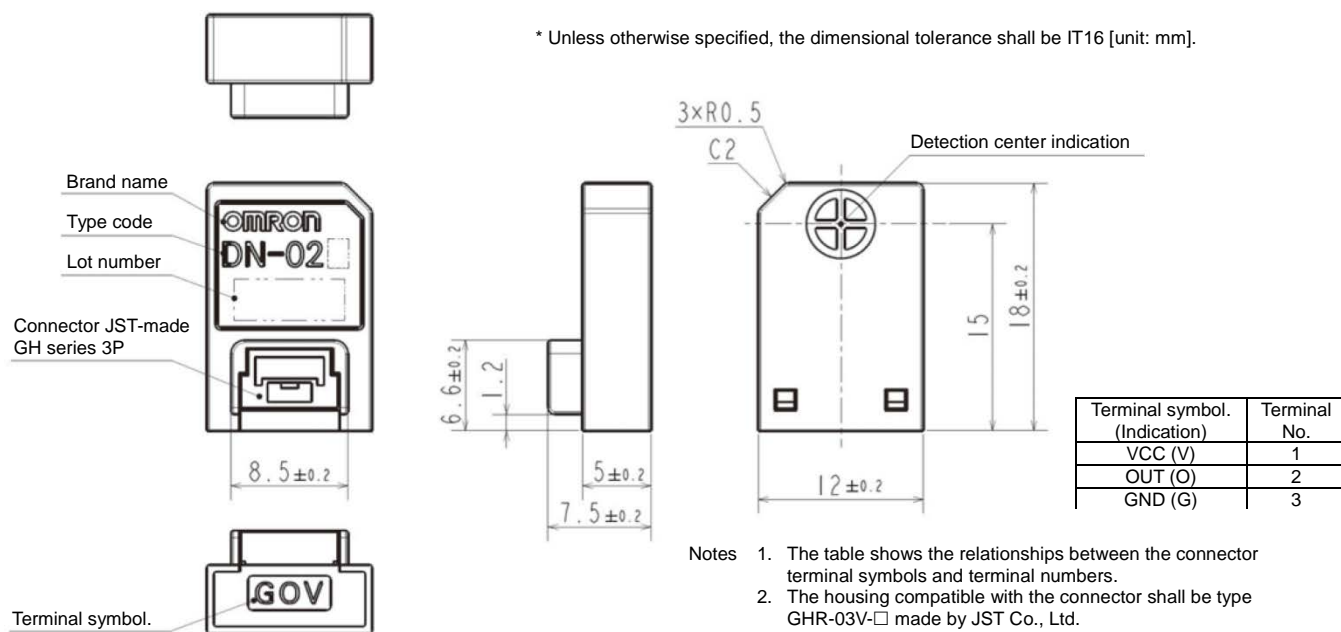

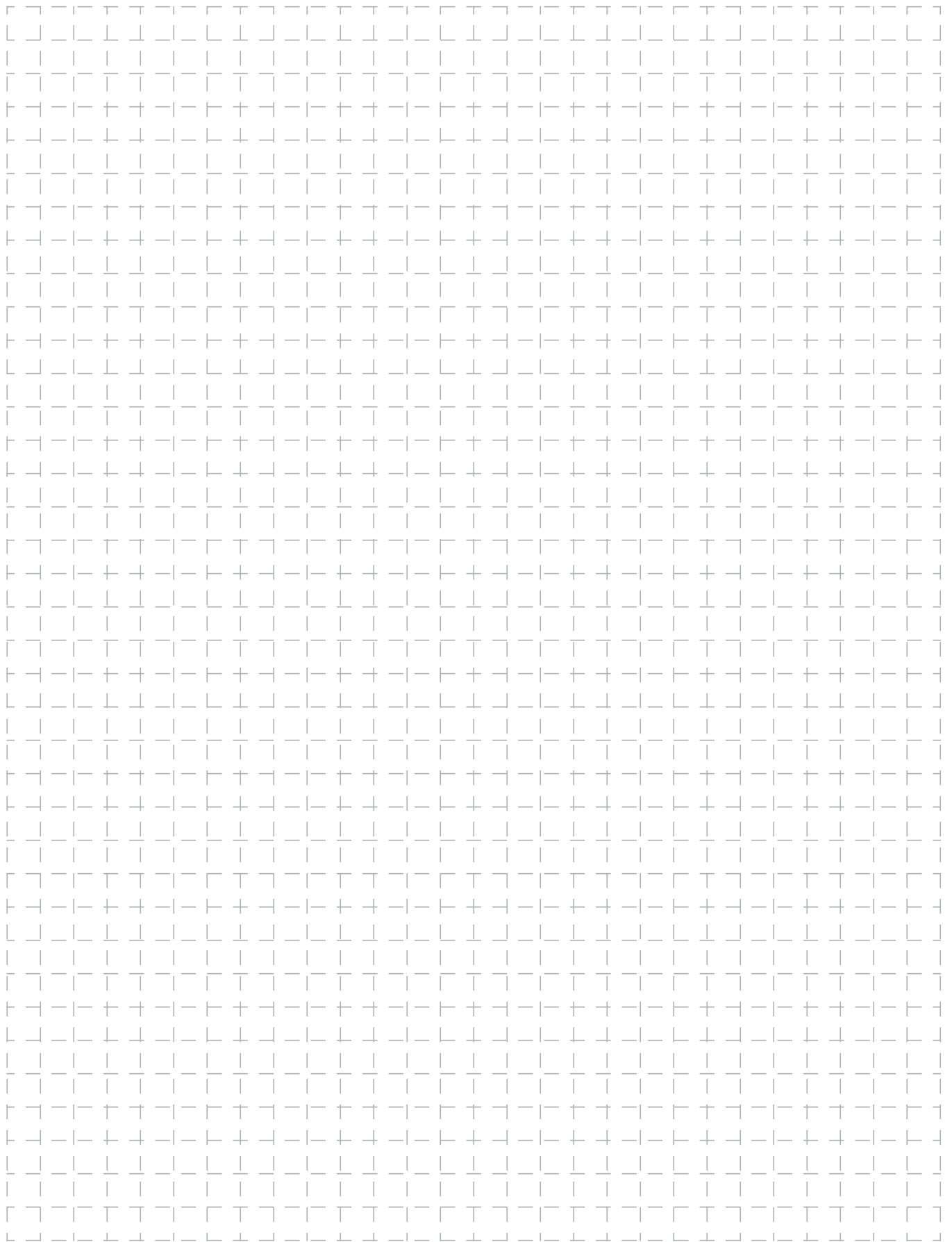

All sales are subject to Omron Electronic Components LLC standard terms and conditions of sale, which can be found at http://www.components.omron.com/components/web/webfiles.nsf/sales_terms.html

ALL DIMENSIONS SHOWN ARE IN MILLIMETERS.
To convert millimeters into inches, multiply by 0.03937. To convert grams into ounces, multiply by 0.03527.

OMRON[®]
**OMRON ELECTRONIC
COMPONENTS LLC**
847-882-2288

OMRON ON-LINE

Global - <http://www.omron.com>
USA - <http://www.components.omron.com>