

#### GENERAL DESCRIPTION

The F2258 is a low insertion loss **V**oltage **V**ariable RF **A**ttenuator (VVA) designed for a multitude of wireless and other RF applications. This device covers a broad frequency range from 50 MHz to 6000 MHz. In addition to providing low insertion loss, the F2258 provides excellent linearity performance over its entire voltage control and attenuation range.

The F2258 uses a single positive supply voltage of 3.15 V to 5.25 V. Another feature includes multi-directional operation meaning the RF input can be applied to either RF1 or RF2 pins. Control voltage ranges from 0 V to 3.6 V.

#### COMPETITIVE ADVANTAGE

F2258 provides extremely low insertion loss and superb IP3, IP2, Return Loss and Slope Linearity across the control range. Comparing to the previous state-of-the-art for silicon VVAs this device is better as follows:

- ✓ Insertion Loss:
  - @ 2000 MHz: 1.4 dB vs. 2.8 dB
  - @ 6000 MHz: 2.7 dB vs. 7.0 dB
- ✓ Maximum Attenuation Slope: 33 dB/Volt vs. 53 dB/Volt
- ✓ Minimum Return Loss up to 6000 MHz: 12.5 dB vs. 7 dB
- ✓ Minimum Output IP3: 31 dBm vs. 15 dBm
- ✓ Minimum Input IP2: 87 dBm vs. 80 dBm
- ✓ Maximum Operating Temperature: +105 °C vs. +85 °C

#### APPLICATIONS

- Base Station 2G, 3G, 4G,
- Portable Wireless
- Repeaters and E911 systems
- Digital Pre-Distortion
- Point to Point Infrastructure
- Public Safety Infrastructure
- Satellite Receivers and Modems
- WIMAX Receivers and Transmitters
- Military Systems, JTRS radios
- RFID handheld and portable readers
- Cable Infrastructure
- Wireless LAN
- Test / ATE Equipment

#### FEATURES

- Low Insertion Loss: 1.4 dB @ 2000 MHz
- Typical / Min IIP3: 65 dBm / 47 dBm
- Typical / Min IIP2: 95 dBm / 87 dBm
- 33.6 dB Attenuation Range
- Bi-directional RF ports
- +34.4 dBm Input P1dB compression
- Linear-in-dB attenuation characteristic
- Supply voltage: 3.15 V to 5.25 V
- $V_{CTRL}$  range: 0 V to 3.6 V using 5 V supply
- +105 °C max operating temperature
- 3 mm x 3 mm, 16-pin QFN package

#### FUNCTIONAL BLOCK DIAGRAM

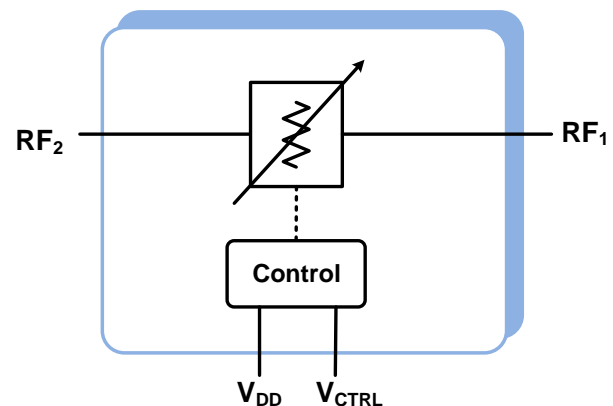

#### ORDERING INFORMATION



## ABSOLUTE MAXIMUM RATINGS

Parameter	Symbol	Min	Max	Units
V <sub>DD</sub> to GND	V <sub>DD</sub>	-0.3	+5.5	V
V <sub>CTRL</sub> to GND (with 0 V ≤ V <sub>DD</sub> ≤ 5.25 V)	V <sub>CTRL</sub>	-0.3	Minimum (V <sub>DD</sub> , +4.0)	V
RF1, RF2 to GND	V <sub>RF</sub>	-0.3	0.3	V
RF1 or RF2 Input Power applied for 24 hours maximum (V <sub>DD</sub> applied @ 2000 MHz and T <sub>case</sub> =+85°C)	P <sub>MAX24</sub>		30	dBm
Junction Temperature	T <sub>j</sub>		150	°C
Storage Temperature Range	T <sub>st</sub>	-65	150	°C
Lead Temperature (soldering, 10s)			260	°C
ElectroStatic Discharge – HBM (JEDEC/ESDA JS-001-2012)	V <sub>ESDHBM</sub>		(Class 1C)	
ElectroStatic Discharge – CDM (JEDEC 22-C101F)	V <sub>ESDCDM</sub>		(Class C3)	

*Stresses above those listed above may cause permanent damage to the device. Functional operation of the device at these or any other conditions above those indicated in the operational section of this specification is not implied. Exposure to absolute maximum rating conditions for extended periods may affect device reliability.*

## PACKAGE THERMAL AND MOISTURE CHARACTERISTICS

θ <sub>JA</sub> (Junction – Ambient)	80.6 °C/W
θ <sub>JC</sub> (Junction – Case) [The Case is defined as the exposed paddle]	5.1 °C/W
Moisture Sensitivity Rating (Per J-STD-020)	MSL1

**F2258 RECOMMENDED OPERATING CONDITIONS**

Parameter	Symbol	Conditions	Min	Typ	Max	Units
Supply Voltage	$V_{DD}$		3.15		5.25	V
Control Voltage	$V_{CTRL}$	$V_{DD} = 3.90\text{ V to }5.25\text{ V}$	0		3.6	V
		$V_{DD} = 3.15\text{ V to }3.90\text{ V}$	0		$V_{DD}-0.3$	
Operating Temperature Range	$T_{CASE}$	Exposed Paddle	-40		+105	°C
Frequency Range	$F_{RF}$		50		6000	MHz
RF Operating Power	$P_{MAX, CW}$	Power can be applied to RF1 or RF2			See Figure 1	dBm
RF1 Port Impedance	$Z_{RF1}$	Single Ended		50		$\Omega$
RF2 Port Impedance	$Z_{RF2}$	Single Ended		50		$\Omega$

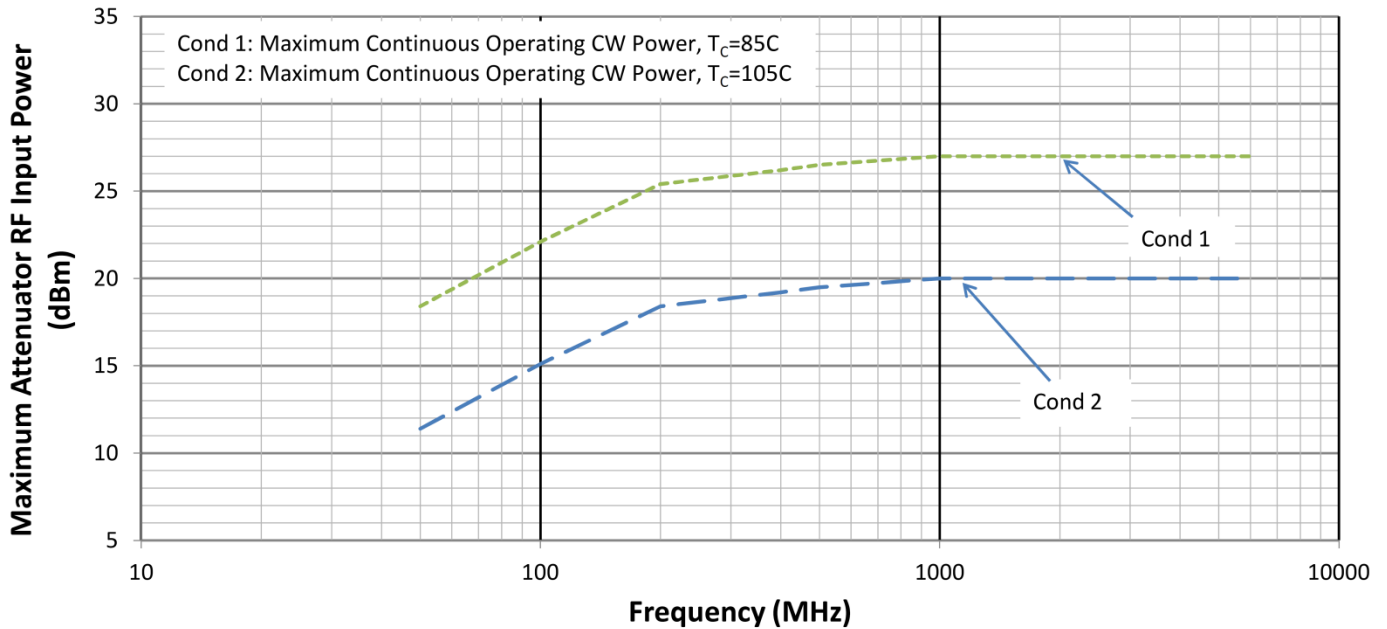

**Figure 1 - MAXIMUM RF INPUT POWER VS. RF FREQUENCY**

## F2258 SPECIFICATION

Refer to EVKit / Applications Circuit,  $V_{DD} = +3.3\text{ V}$ ,  $T_{CASE} = +25\text{ }^{\circ}\text{C}$ , signal applied to RF1 input,  $F_{RF} = 2000\text{ MHz}$ , minimum attenuation,  $P_{IN} = 0\text{ dBm}$  for small signal parameters,  $+20\text{ dBm}$  for single tone linearity tests,  $+20\text{ dBm}$  per tone for two tone tests, two tone delta frequency =  $50\text{ MHz}$ , PCB board traces and connector losses are de-embedded unless otherwise noted. Refer to Typical Operating Curves for performance over entire frequency band.

Parameter	Symbol	Conditions	Min	Typ	Max	Units
Supply Current	$I_{DD}$		<b><i>0.5</i></b> <sup>1</sup>	1.17	<b>2</b>	mA
$I_{CTRL}$ Current	$I_{CTRL}$		<b><i>-1.0</i></b>		<b>14</b>	$\mu\text{A}$
Insertion Loss, IL	$A_{MIN}$	Minimum Attenuation		1.4	<b><i>1.9</i></b>	dB
Maximum Attenuation	$A_{MAX}$		34 <sup>2</sup>	35		dB
Insertion Phase $\Delta$	$\Phi_{\Delta MAX}$	At 36 dB attenuation relative to Insertion Loss		27		Deg
	$\Phi_{\Delta MID}$	At 18 dB attenuation relative to Insertion Loss		10		
Input 1dB Compression <sup>3</sup>	P1dB			34.4		dBm
Minimum RF1 Return Loss over control voltage range	$S_{11}$	50 MHz <sup>4</sup>		16		dB
		700 MHz		17		
		2000 MHz		17		
		6000 MHz		15		
Minimum RF2 Return Loss over control voltage range	$S_{22}$	50 MHz <sup>4</sup>		16		dB
		700 MHz		15		
		2000 MHz		16		
		6000 MHz		13		
Input IP3	IIP3			65		dBm
	IIP3 <sub>MIN</sub>	All attenuation settings	44	47		
Output IP3	OIP3 <sub>MIN</sub>	Maximum attenuation		35		dBm
Input IP2	IIP2	$P_{IN} + IM2_{dBc}$ , IM2 term is F1+F2		95		dBm
	IIP2 <sub>MIN</sub>	All attenuation settings		87		
Input IH2	HD2	$P_{IN} + H2_{dBc}$		90		dBm
Input IH3	HD3	$P_{IN} + (H3_{dBc}/2)$		54		dBm
Settling Time	$T_{SETTL0.1dB}$	Any 1 dB step in the 0 dB to 33 dB control range 50% $V_{CTRL}$ to RF settled to within $\pm 0.1\text{ dB}$		15		$\mu\text{s}$

Note 1: Items in min/max columns in ***bold italics*** are Guaranteed by Test.

Note 2: Items in min/max columns that are not bold/italics are Guaranteed by Design Characterization.

Note 3: The input 1dB compression point is a linearity figure of merit. Refer to Absolute Maximum Ratings section along with Figure 1 for the maximum RF input power vs. RF frequency.

Note 4: Set blocking capacitors C1 & C2 to 0.01 $\mu\text{F}$  to achieve best return loss performance at 50 MHz.

## TYPICAL OPERATING CONDITIONS (TOC)

Unless otherwise noted for the TOC graphs on the following pages, the following conditions apply.

- **$V_{DD} = +3.3 \text{ V}$  or  $+5.0 \text{ V}$**
- **$T_{CASE} = +25 \text{ }^{\circ}\text{C}$**
- **$F_{RF} = 2000 \text{ MHz}$**
- **RF trace and connector losses are de-embedded for S-parameters**
- **$P_{in} = 0 \text{ dBm}$  for all small signal tests**
- **$P_{in} = +20 \text{ dBm}$  for single tone linearity tests (RF1 port driven)**
- **$P_{in} = +20 \text{ dBm/tone}$  for two tone linearity tests (RF1 port driven)**
- **Two tone frequency spacing = 50 MHz**

## TYPICAL OPERATING CONDITIONS [S2P BROADBAND PERFORMANCE] (- 1 -)

Attenuation vs.  $V_{CTRL}$

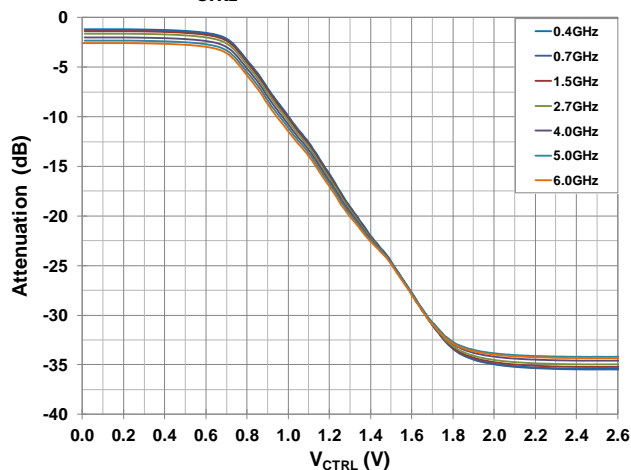

Attenuation vs. Frequency

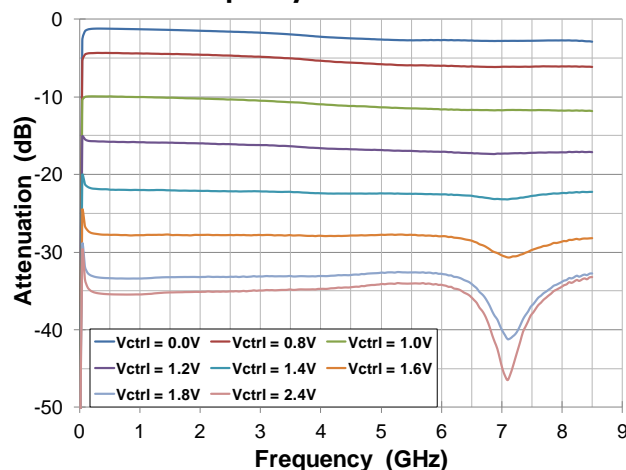

Min. & Max. Attenuation vs. Frequency

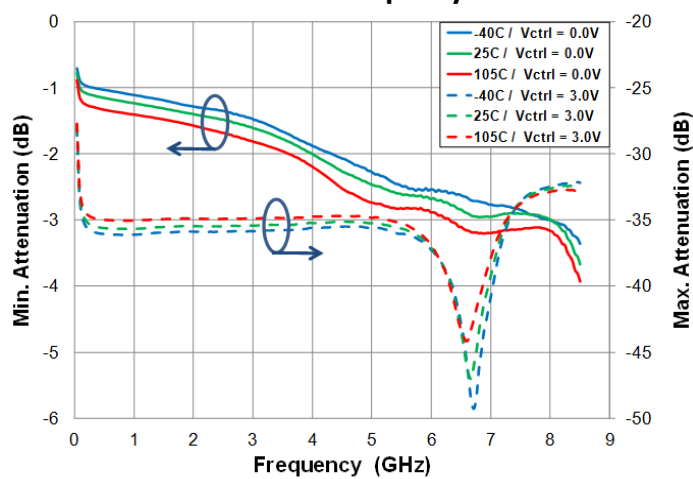

Attenuation Delta to 25C vs. Frequency

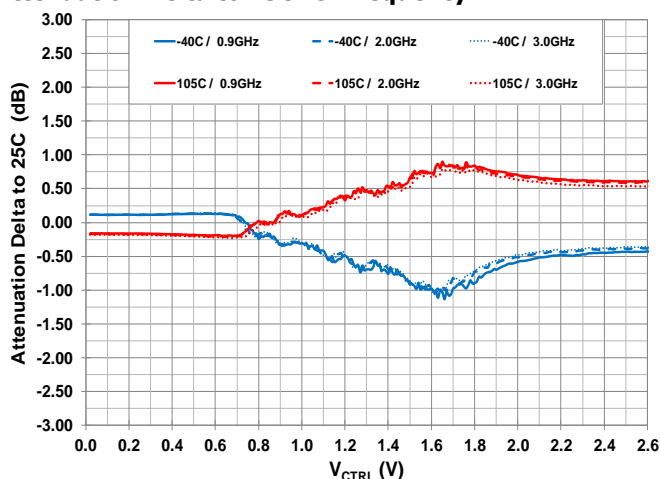

TYPICAL OPERATING CONDITIONS [S2P vs.  $V_{CTRL}$ ] (- 2 -)

Attenuation vs.  $V_{CTRL}$

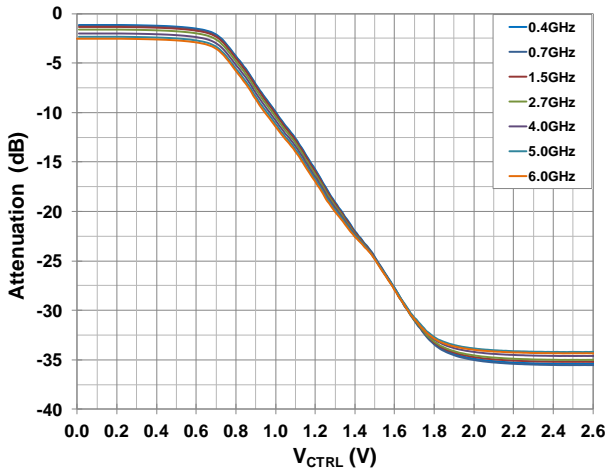

Attenuation Slope vs.  $V_{CTRL}$

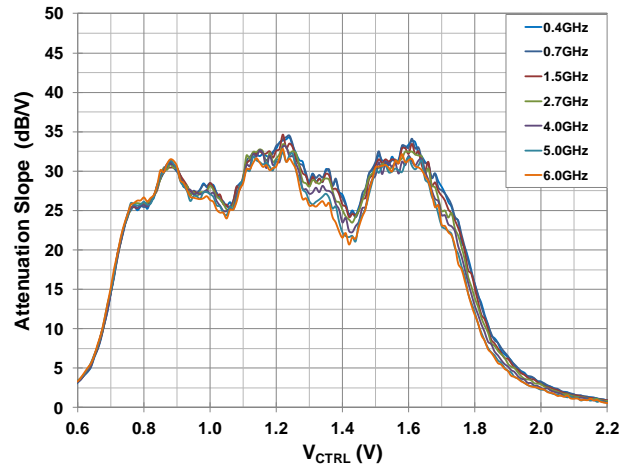

RF1 Return Loss vs.  $V_{CTRL}$

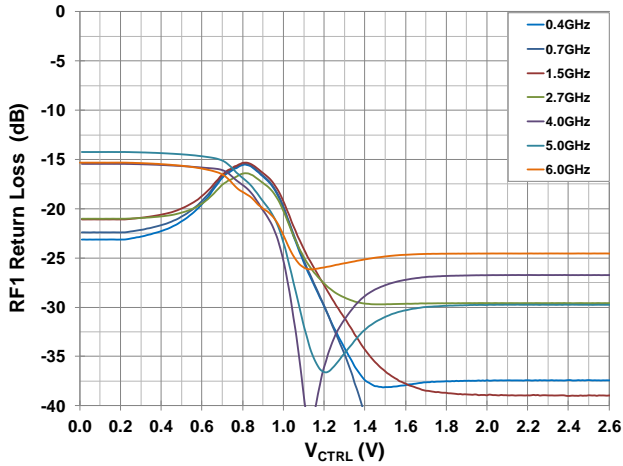

RF2 Return Loss vs.  $V_{CTRL}$

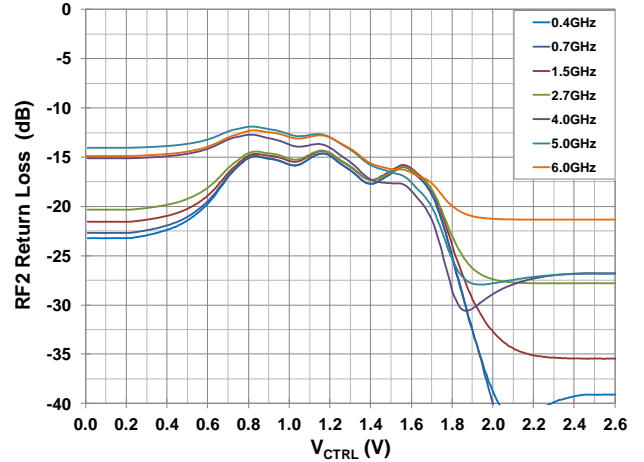

Insertion Phase  $\Delta$  vs.  $V_{CTRL}$

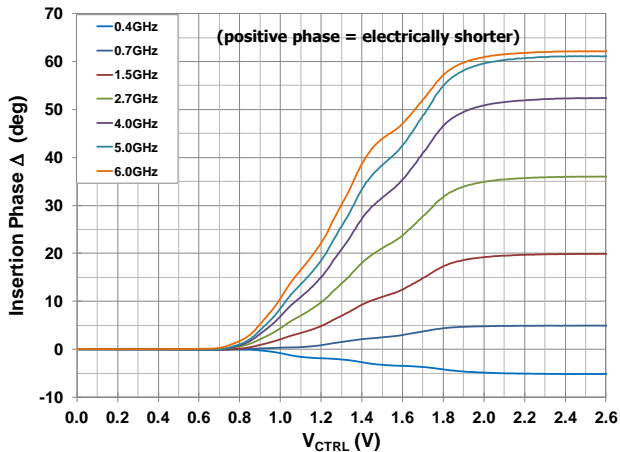

Insertion Phase Slope vs.  $V_{CTRL}$

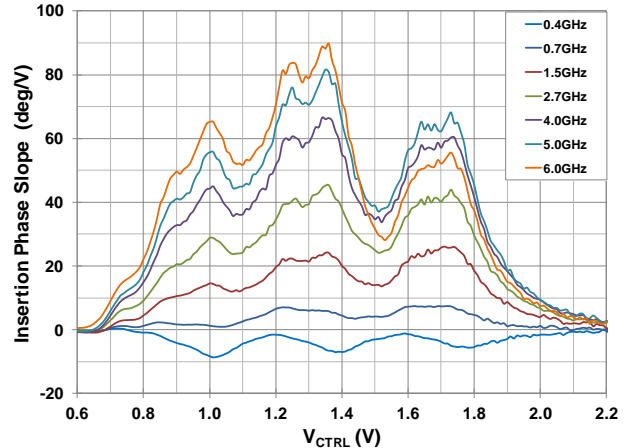

## TYPICAL OPERATING CONDITIONS [S2P vs. $V_{CTRL}$ & TEMPERATURE] (- 3 -)

**Attenuation Response vs.  $V_{CTRL}$**

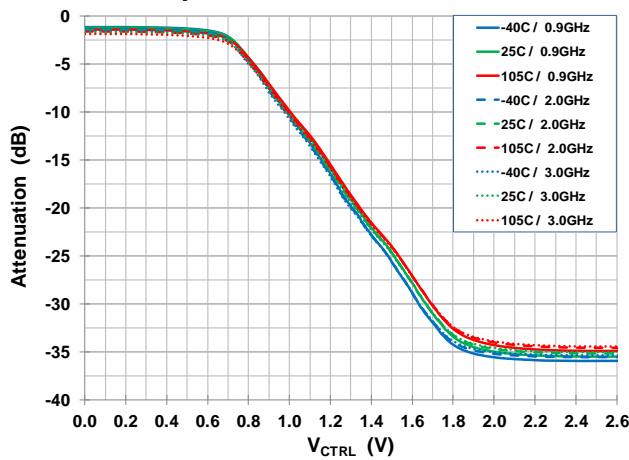

**Attenuation Slope vs.  $V_{CTRL}$**

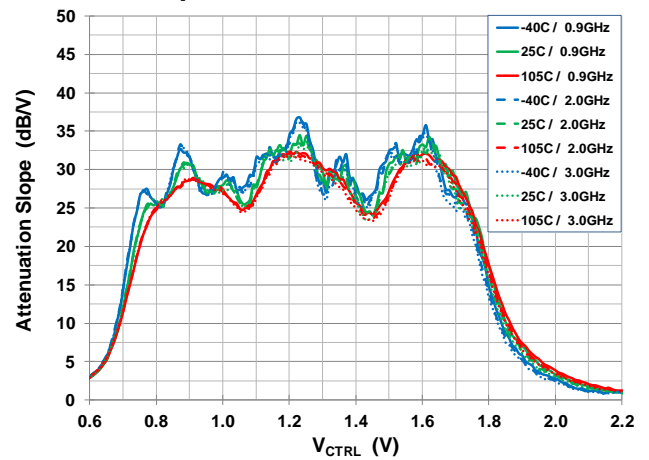

**RF1 Return Loss vs.  $V_{CTRL}$**

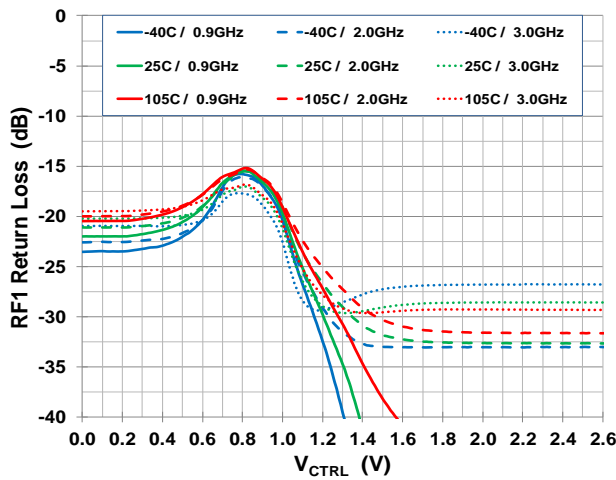

**RF2 Return Loss vs.  $V_{CTRL}$**

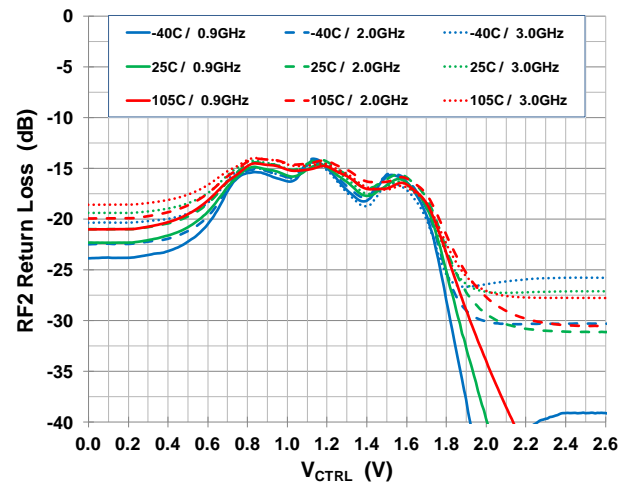

**Insertion Phase  $\Delta$  vs.  $V_{CTRL}$**

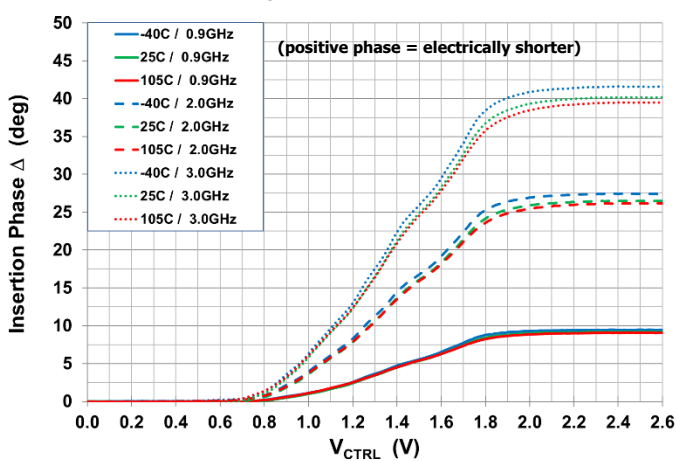

**Insertion Phase Slope vs.  $V_{CTRL}$**

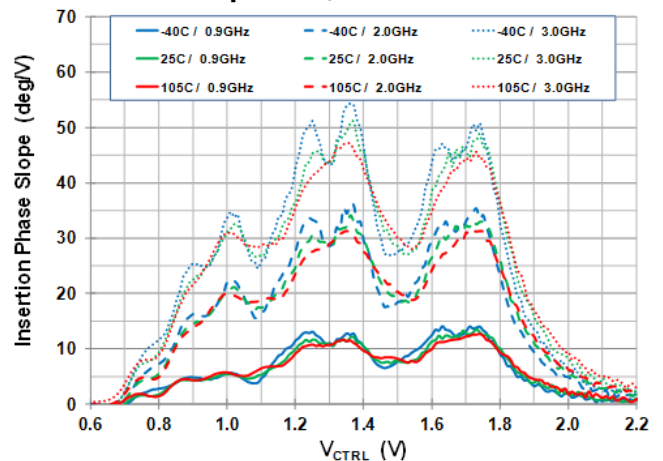



**TYPICAL OPERATING CONDITIONS [S2P vs. ATTENUATION & TEMPERATURE] (- 4 -)**

**RF1 Return Loss vs. Attenuation**

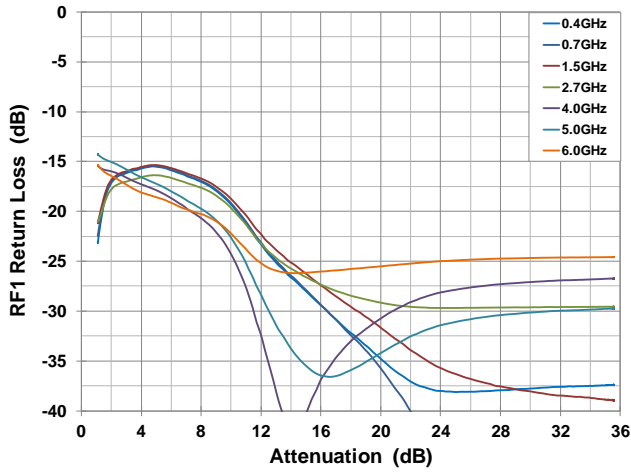

**RF1 Return Loss vs. Attenuation**

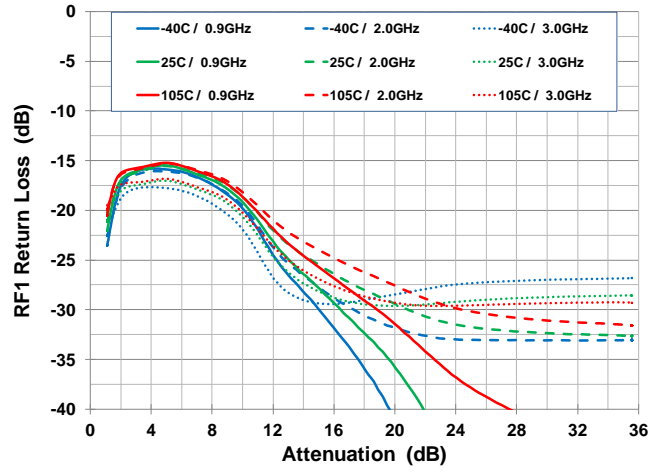

**RF2 Return Loss vs. Attenuation**

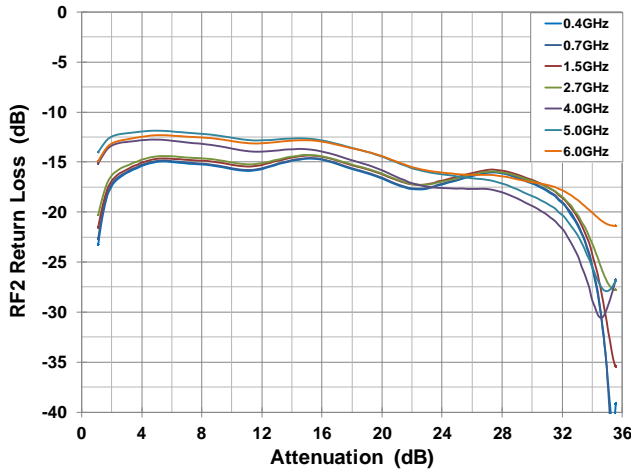

**RF2 Return Loss vs. Attenuation**

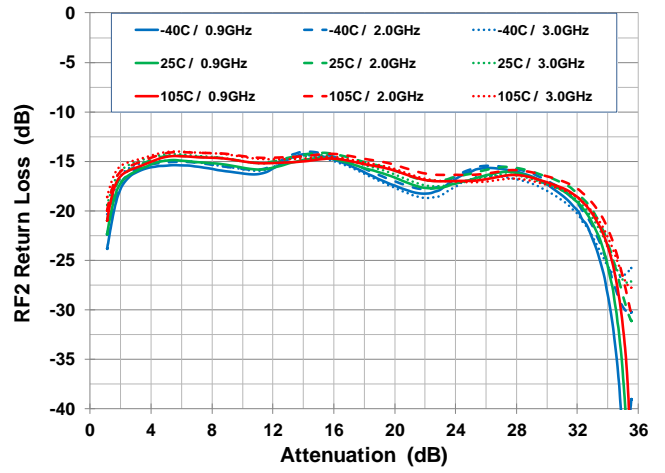

**Insertion Phase Δ vs. Attenuation**

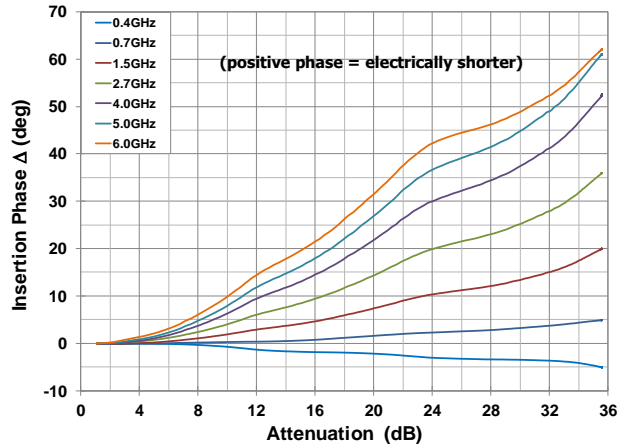

**Insertion Phase Δ vs. Attenuation**

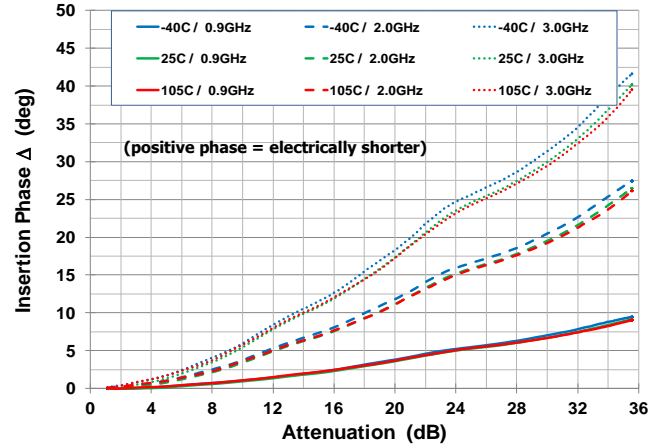

## TYPICAL OPERATING CONDITIONS [S2P vs. FREQUENCY] (- 5 -)

Min & Max. Attenuation vs. Frequency

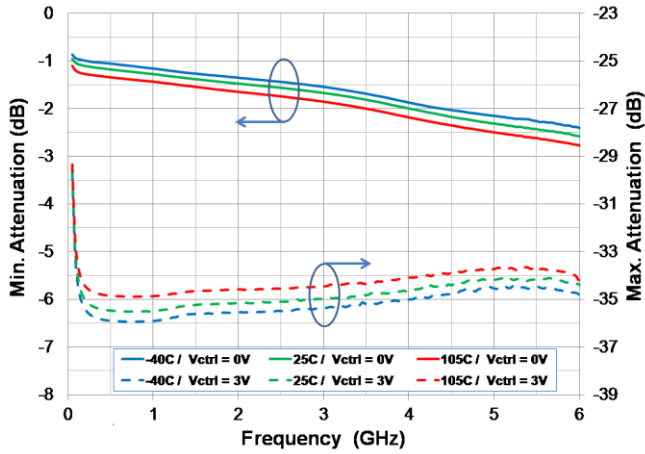

Min. & Max. Attenuation Slope vs. Frequency

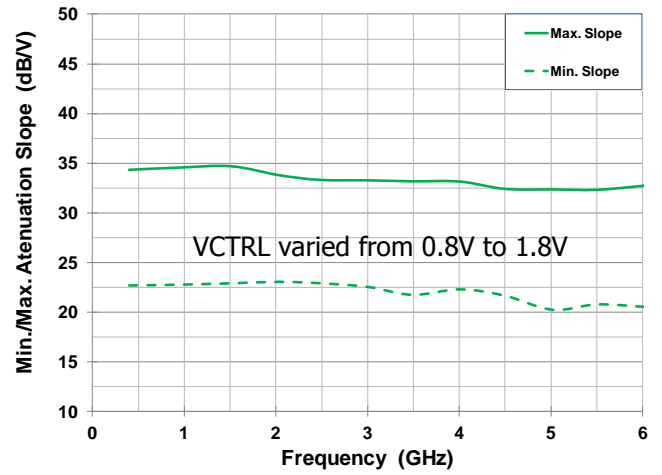

Worst-Case RF1 Return Loss vs. Frequency

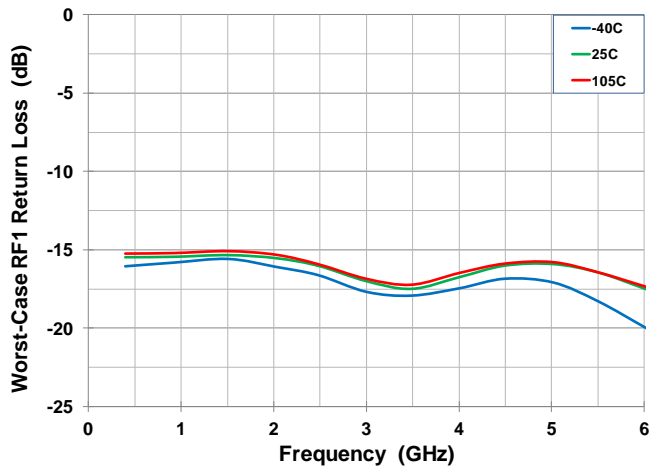

Worst-Case RF2 Return Loss vs. Frequency

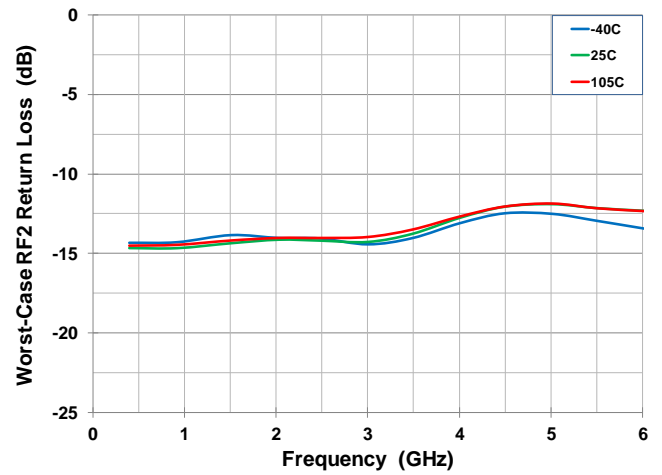

Max. Insertion Phase Δ vs. Frequency

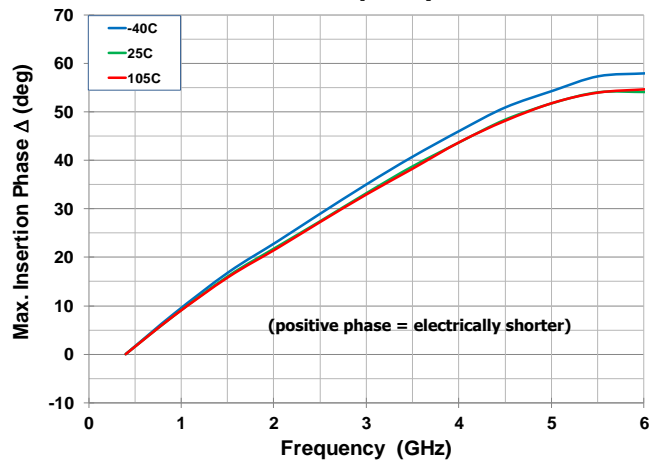

Gain Compression vs. Frequency

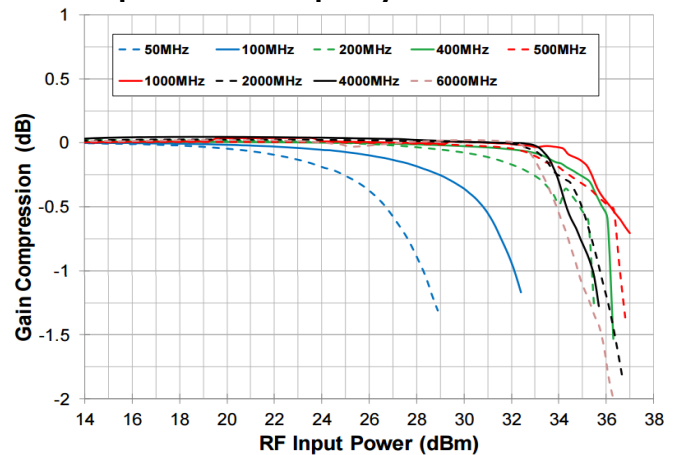

**TYPICAL OPERATING CONDITIONS [S2P @ LOW FREQUENCY, GROUP DELAY] (- 6 -)**

**Min & Max. Attenuation vs. Low Frequency**

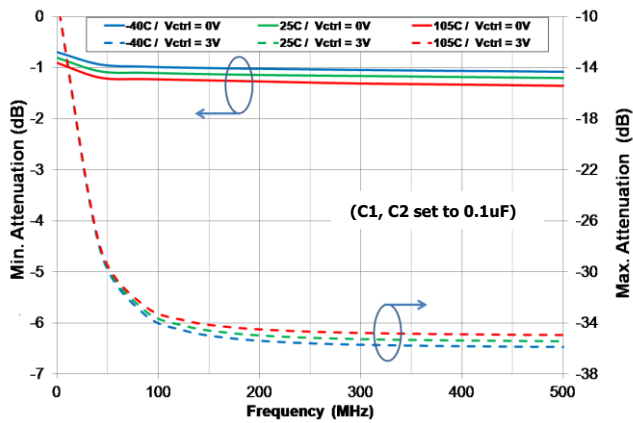

**Low-Frequency Attenuation vs. V<sub>CTRL</sub>**

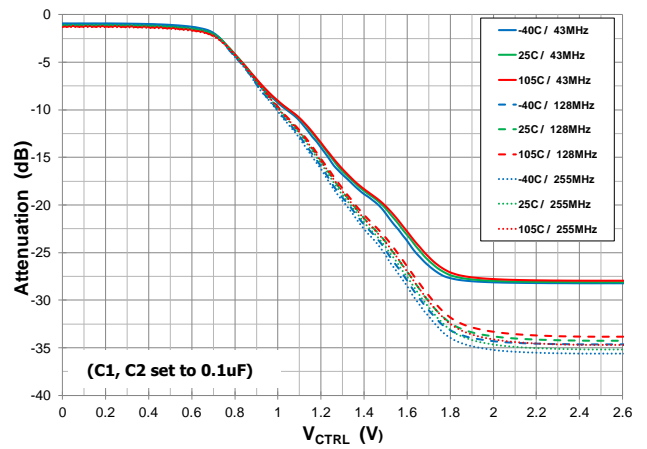

**Low-Frequency RF1 Return Loss vs. V<sub>CTRL</sub>**

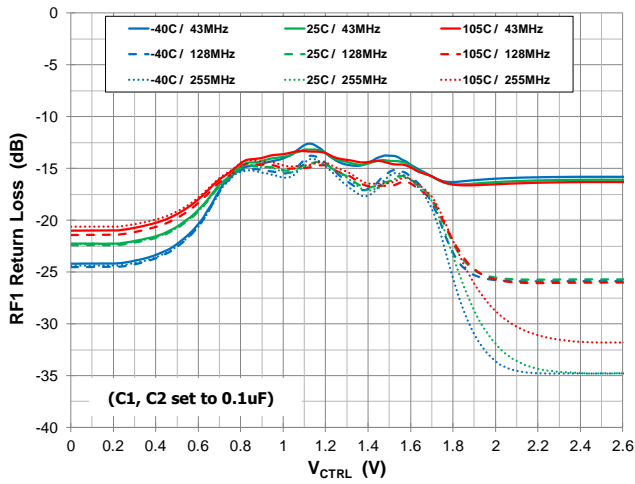

**Low-Frequency RF2 Return Loss vs. V<sub>CTRL</sub>**

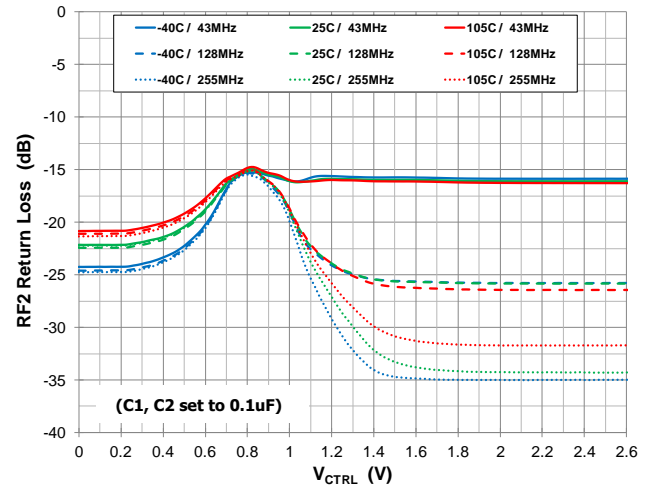

**Worst-Case Return Loss vs. Low Frequency**

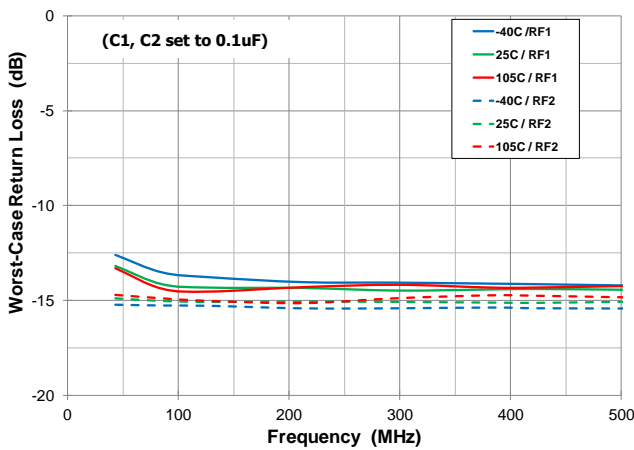

**Group Delay vs. V<sub>CTRL</sub>**

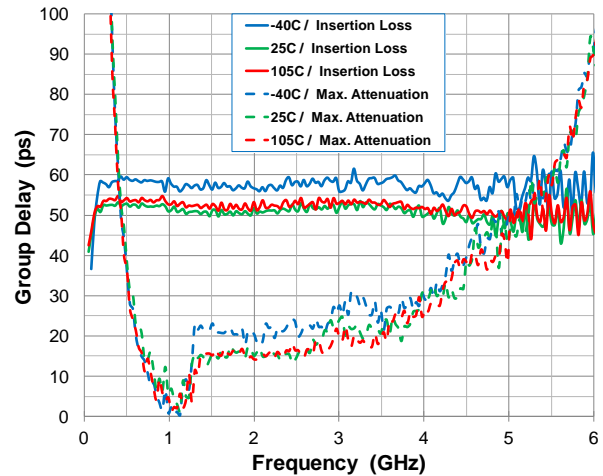

**TYPICAL OPERATING CONDITIONS 2GHz,  $V_{DD}=3.3V$  [IP3, IP2, IH2, IH3 vs.  $V_{CTRL}$ ] (- 7 -)**

**Input IP3 vs.  $V_{CTRL}$**

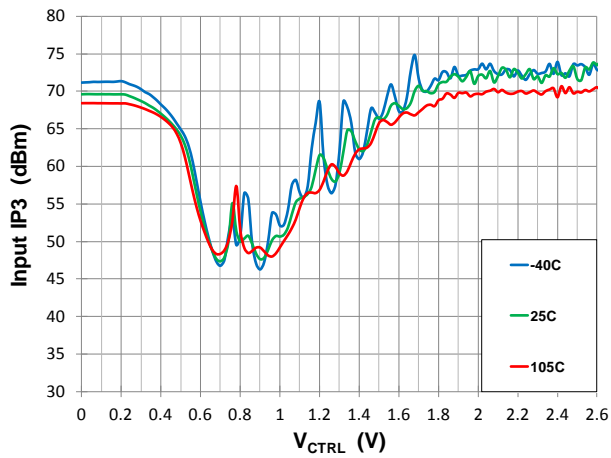

**Output IP3 vs.  $V_{CTRL}$**

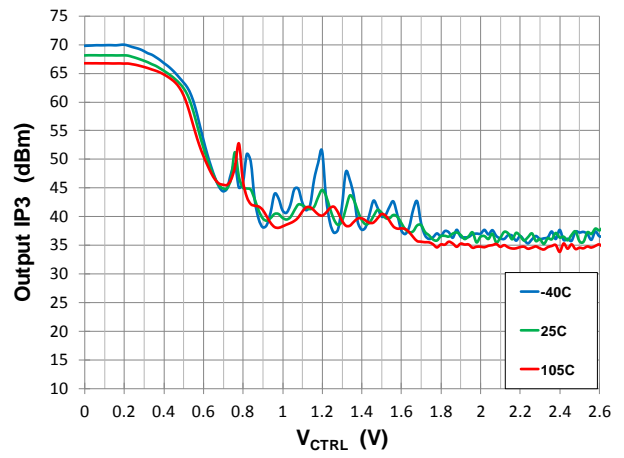

**Input IP2 vs.  $V_{CTRL}$**

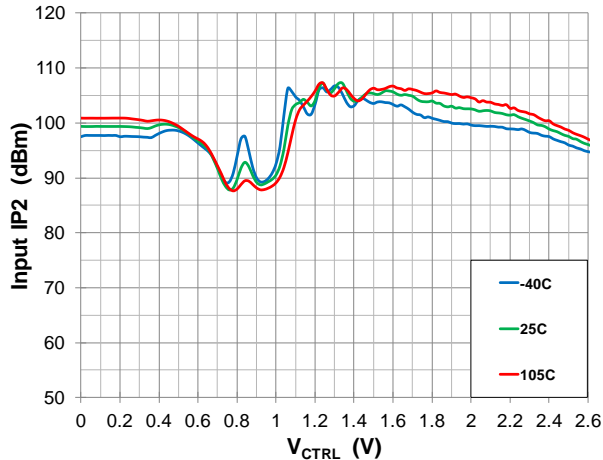

**Output IP2 vs.  $V_{CTRL}$**

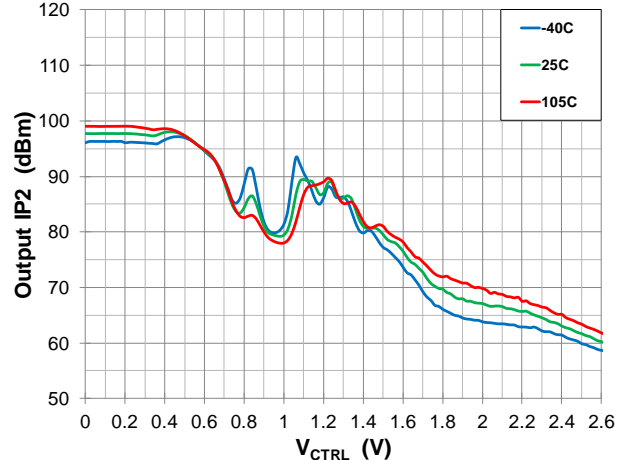

**2nd Harm Input Intercept Point vs.  $V_{CTRL}$**

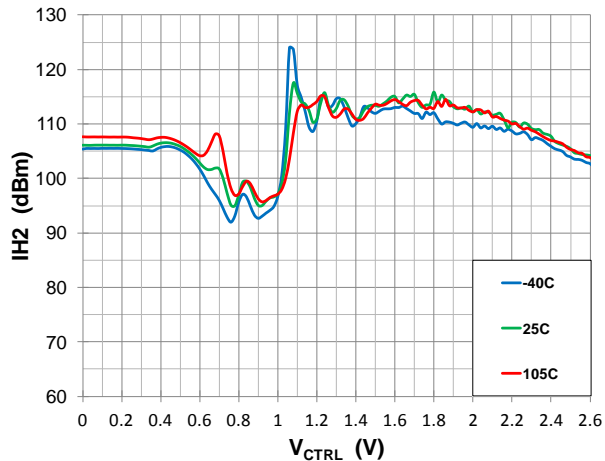

**3rd Harm Input Intercept Point vs.  $V_{CTRL}$**

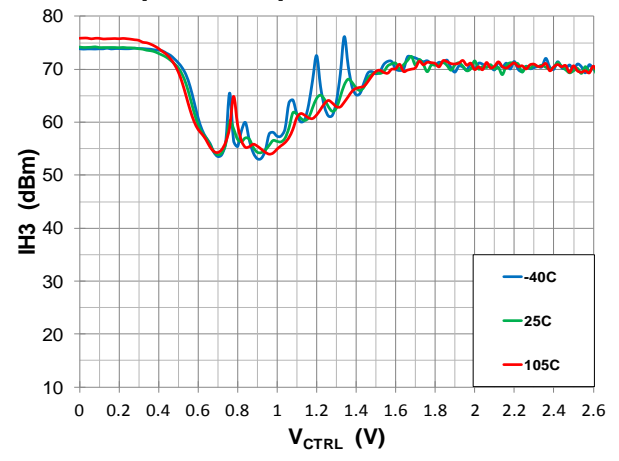

**TYPICAL OPERATING CONDITIONS 2GHZ, V<sub>DD</sub>=3.3V [IP<sub>3</sub>, IP<sub>2</sub>, IH<sub>2</sub>, IH<sub>3</sub> vs. V<sub>CTRL</sub>, RF1/RF2 DRIVEN] (- 8 -)**

**Input IP3 vs. V<sub>CTRL</sub>**

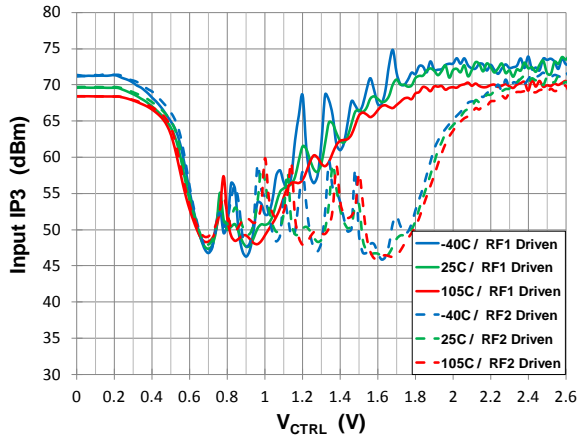

**Output IP3 vs. V<sub>CTRL</sub>**

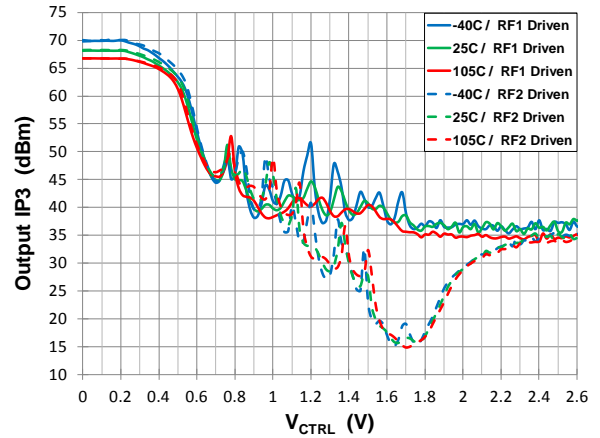

**Input IP2 vs. V<sub>CTRL</sub>**

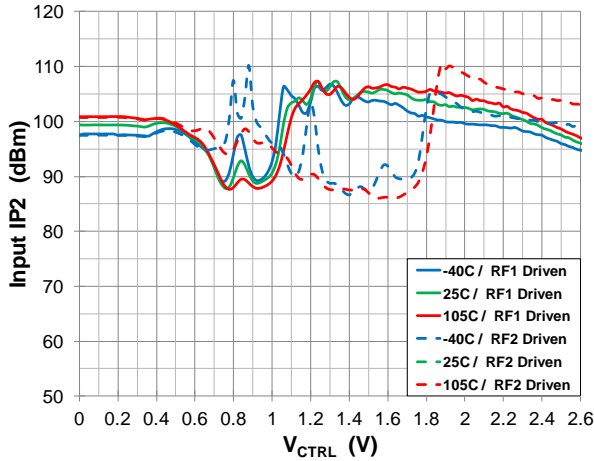

**Output IP2 vs. V<sub>CTRL</sub>**

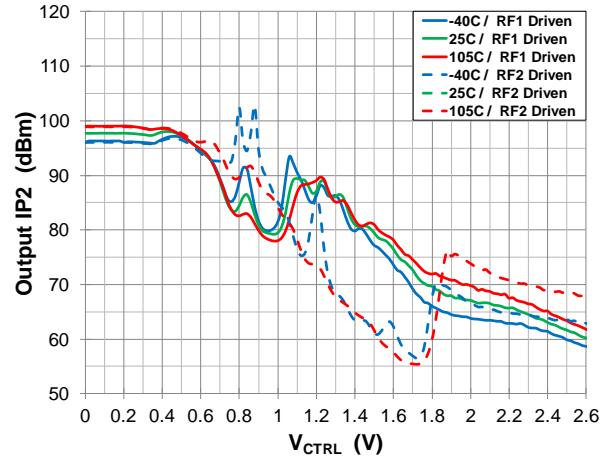

**2<sup>nd</sup> Harm Input Intercept Point vs. V<sub>CTRL</sub>**

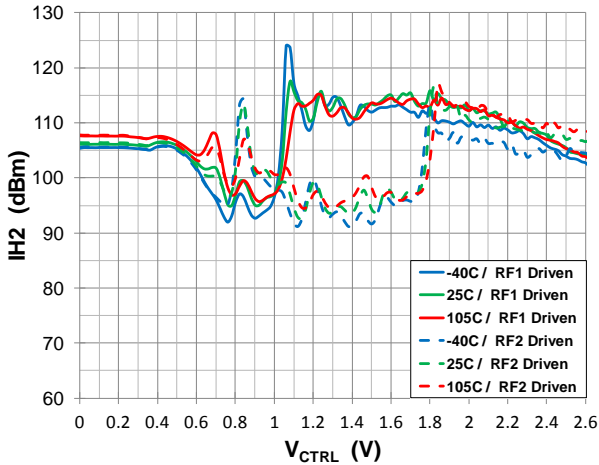

**3<sup>rd</sup> Harm Input Intercept Point vs. V<sub>CTRL</sub>**

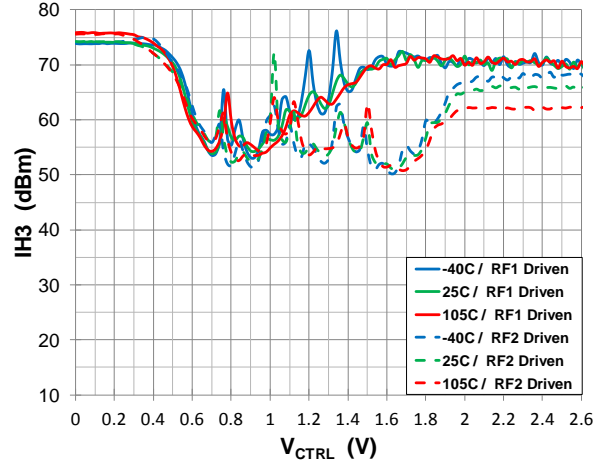

**TYPICAL OPERATING CONDITIONS 2GHz,  $V_{DD}=3.3V$  [IP3, IP2, IH2, IH3 vs. ATTENUATION] (- 9 -)**

**Input IP3 vs. Attenuation**

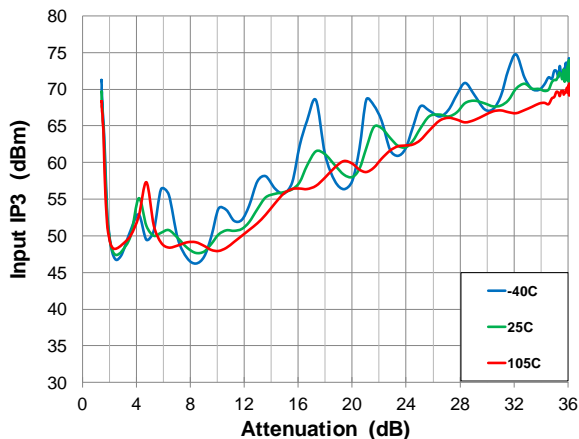

**Output IP3 vs. Attenuation**

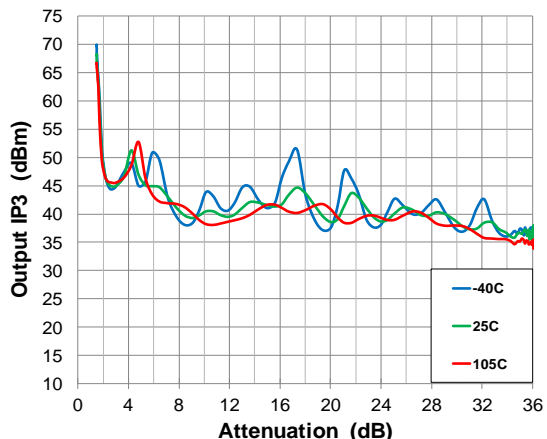

**Input IP2 vs. Attenuation**

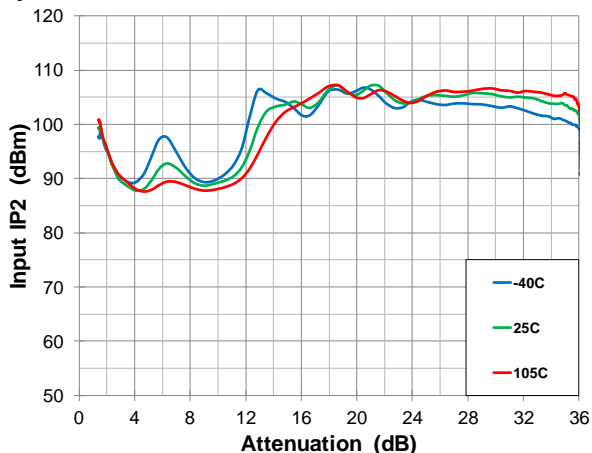

**Output IP2 vs. Attenuation**

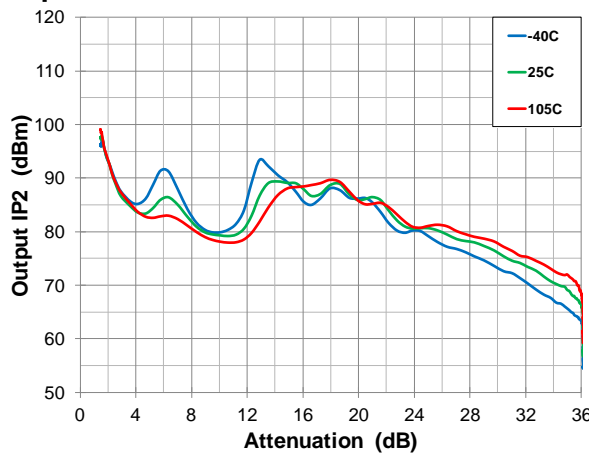

**2<sup>nd</sup> Harm Input Intercept Point vs. Attenuation**

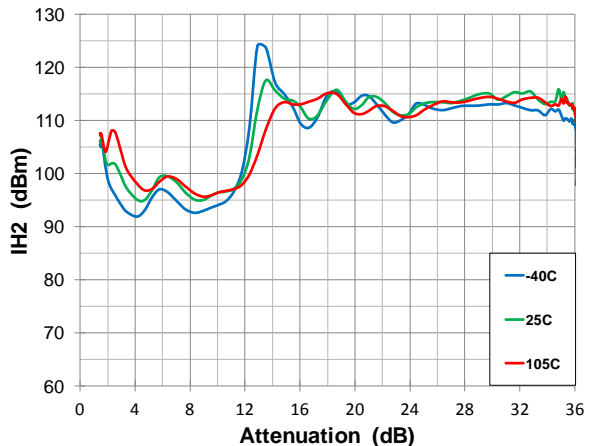

**3<sup>rd</sup> Harm Input Intercept Point vs. Attenuation**

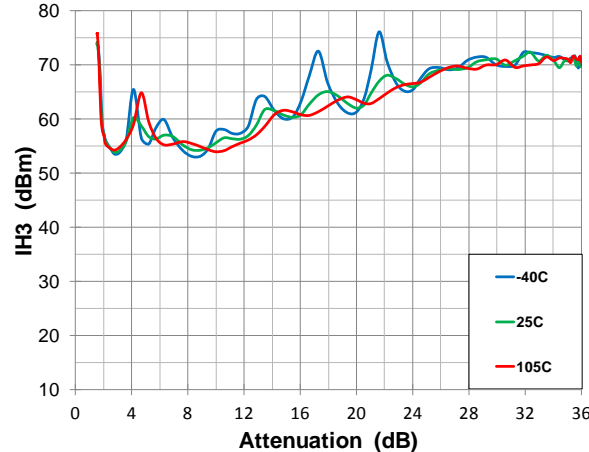

**TYPICAL OPERATING CONDITIONS 2GHZ, V<sub>DD</sub>=3.3V [IP3, IP2, IH2, IH3 vs. V<sub>CTRL</sub>, RF1/RF2 DRIVEN] (- 10 -)**

**Input IP3 vs. Attenuation**

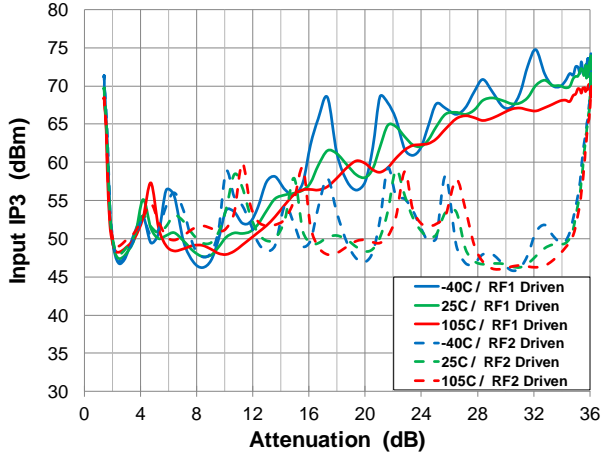

**Output IP3 vs. Attenuation**

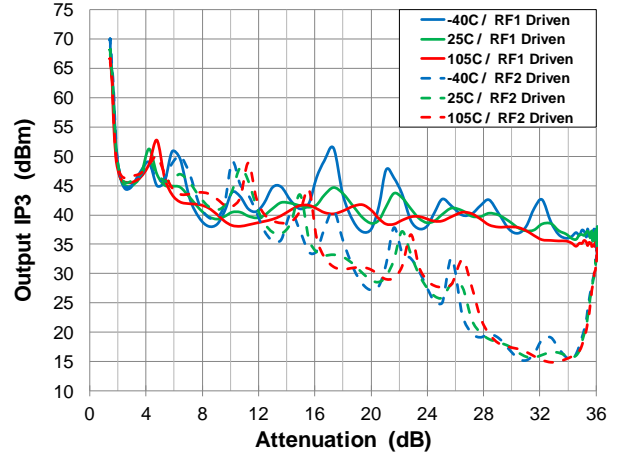

**Input IP2 vs. Attenuation**

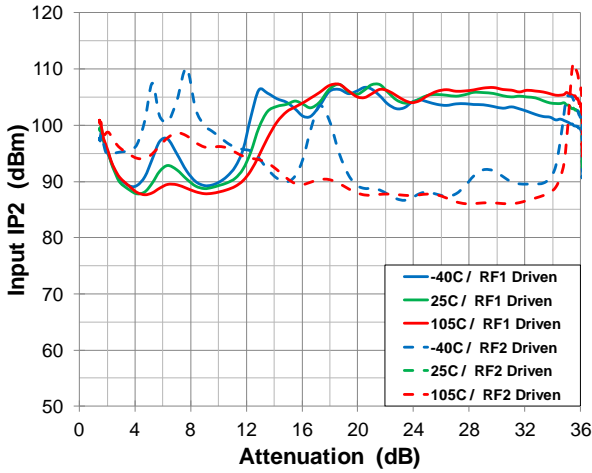

**Output IP2 vs. Attenuation**

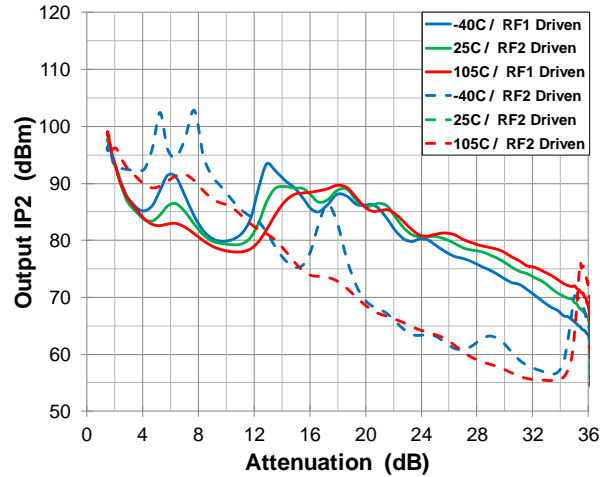

**2<sup>nd</sup> Harm Input Intercept Point vs. Attenuation**

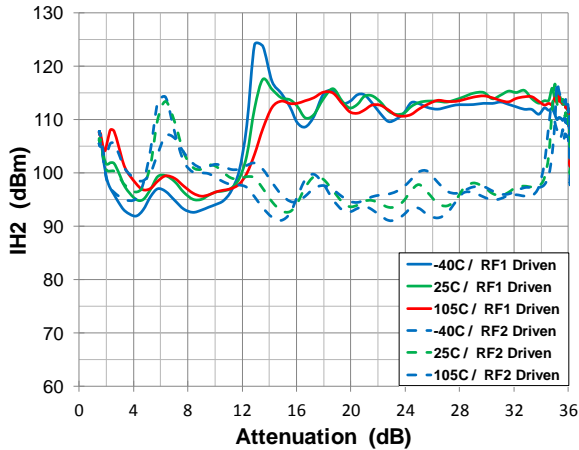

**3<sup>rd</sup> Harm Input Intercept Point vs. Attenuation**

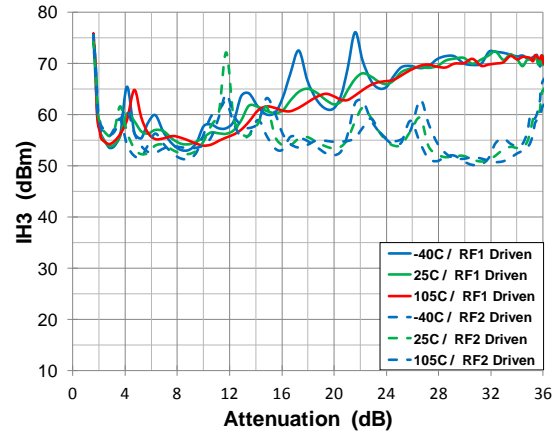

**PACKAGE DRAWING**

(3mm x 3mm 16-pin QFN), NLG16

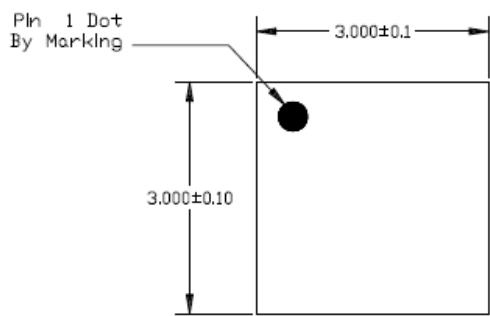

TOP VIEW

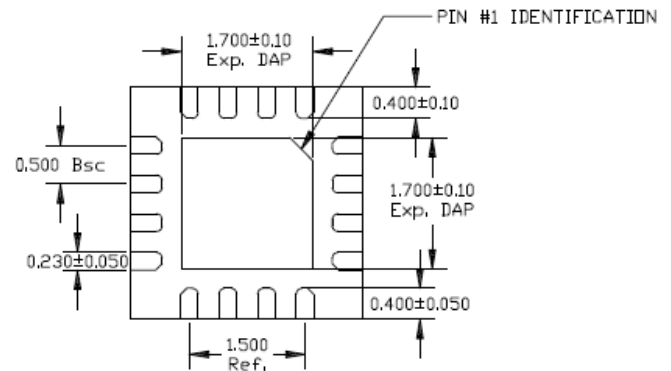

BOTTOM VIEW

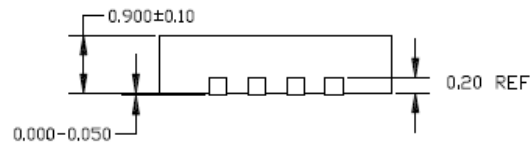

TOP VIEW

16LD QFN 3X3 (0.5MM PITCH)



**LAND PATTERN DIMENSION**

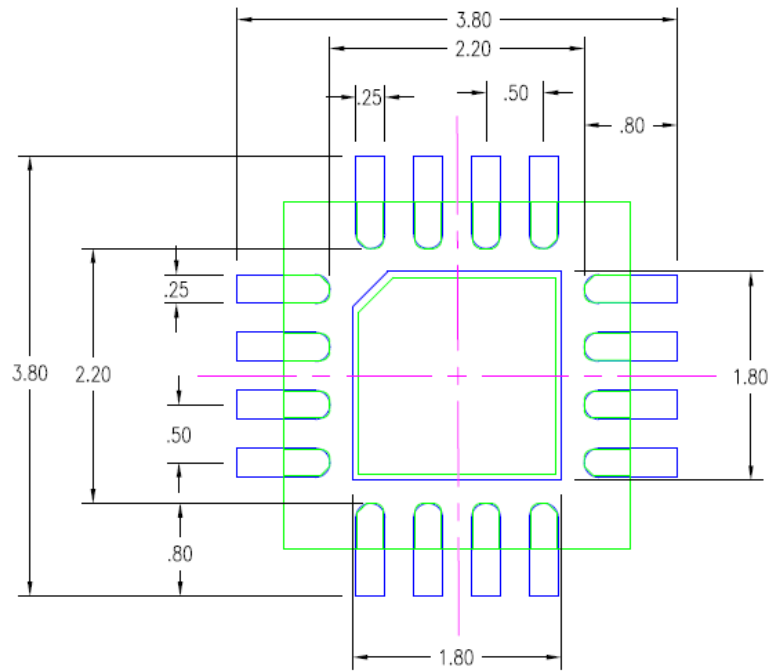

**NOTES:**

1. ALL DIMENSION ARE IN mm. ANGLES IN DEGREES.
2. TOP DOWN VIEW, AS VIEWED ON PCB.
3. COMPONENT OUTLINE SHOW FOR REFERENCE IN GREEN.
4. LAND PATTERN IN BLUE. NSMD PATTERN ASSUMED.
5. LAND PATTERN RECOMMENDATION PER IPC-7351B GENERIC REQUIREMENT FOR SURFACE MOUNT DESIGN AND LAND PATTERN.

## PIN DIAGRAM

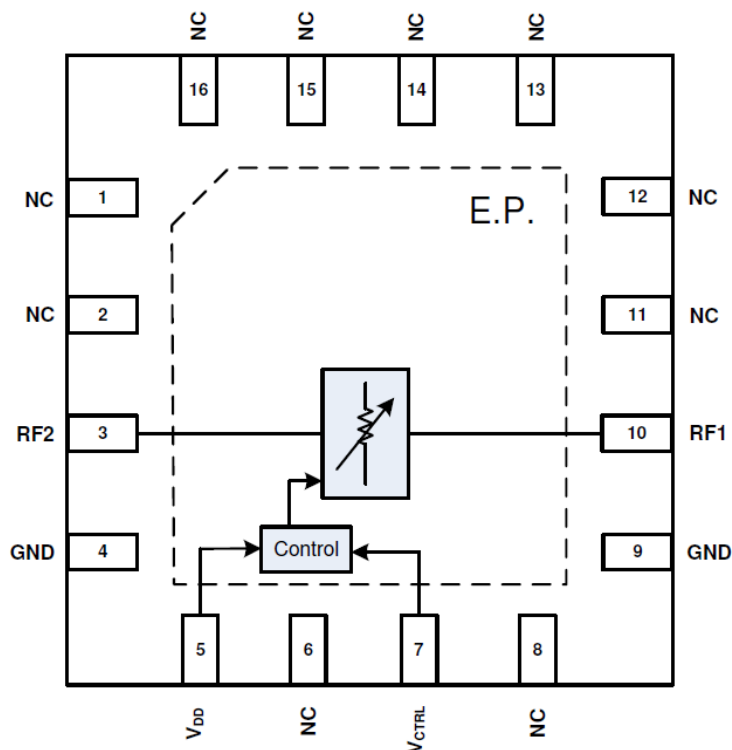

## PIN DESCRIPTION

Pin	Name	Function
4, 9	GND	Ground these pins as close to the device as possible.
3	RF2	RF Port 2. Matched to 50 ohms. Must use an external AC coupling capacitor as close to the device as possible. For low frequency operation increase the capacitor value to result in a low reactance at the frequency of interest.
5	V <sub>DD</sub>	Power supply input. Bypass to GND with capacitors close as possible to pin.
1, 2, 6, 8, 11, 12, 13, 14, 15, 16	NC	No internal connection. These pins can be left unconnected or connected to ground.
7	V <sub>CTRL</sub>	Attenuator control voltage. Apply a voltage in the range as specified in the Operating Conditions Table. See application section for details about V <sub>CTRL</sub> .
10	RF1	RF Port 1. Matched to 50 ohms. Must use an external AC coupling capacitor as close to the device as possible. For low frequency operation increase the capacitor value to result in a low reactance at the frequency of interest.
—	EP	Exposed Pad. Internally connected to GND. Solder this exposed pad to a PCB pad that uses multiple ground vias to achieve the specified RF performance.

## APPLICATIONS INFORMATION

### Default Start-up

The  $V_{CTRL}$  pin has an internal pull-down resistor. If left floating, the part will power up in the minimum attenuation state.

### V<sub>CTRL</sub>

The  $V_{CTRL}$  pin is used to control the attenuation of the F2258. With  $V_{DD} = 5\text{ V}$  the control range of  $V_{CTRL}$  is from 0 V (minimum attenuation) to 3.6 V (maximum attenuation). For other settings of  $V_{DD}$  refer to the Operating Conditions Table. Apply  $V_{DD}$  before applying voltage to the  $V_{CTRL}$  pin to prevent damage to the on-chip pull-up ESD diode. If this sequencing is not possible, then set resistor R2 to 1k $\Omega$  to limit the current into the  $V_{CTRL}$  pin.

### RF1 and RF2 Ports

The F2258 is a bi-directional device thus allowing RF1 or RF2 to be used as the RF input. As displayed in the Typical Operating Conditions curves, RF1 shows enhanced linearity.  $V_{DD}$  must be applied prior to the application of RF power to ensure reliability. DC blocking capacitors are required on the RF pins and should be set to a value that results in a low reactance over the frequency range of interest.

### Power Supplies

The supply pin should be bypassed with external capacitors to minimize noise and fast transients. Supply noise can degrade noise figure and fast transients can trigger ESD clamps and cause them to fail. Supply voltage change or transients should have a slew rate smaller than 1V/20 $\mu$ S. In addition, all control pins should remain at 0V (+/-0.3V) while the supply voltage ramps or while it returns to zero.

### Control Pin Interface

If control signal integrity is a concern and clean signals cannot be guaranteed due to overshoot, undershoot, ringing, etc., the following circuit at the input of control pin 7 is recommended as shown below.

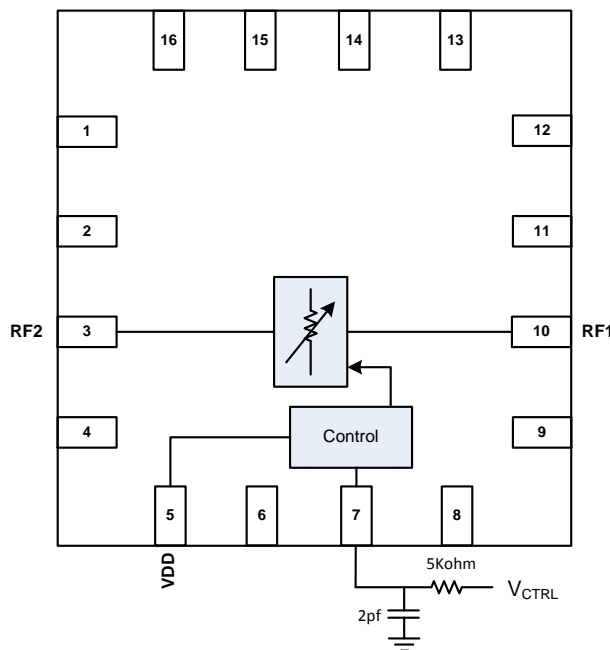

**EVKIT PICTURE**

**Top View**

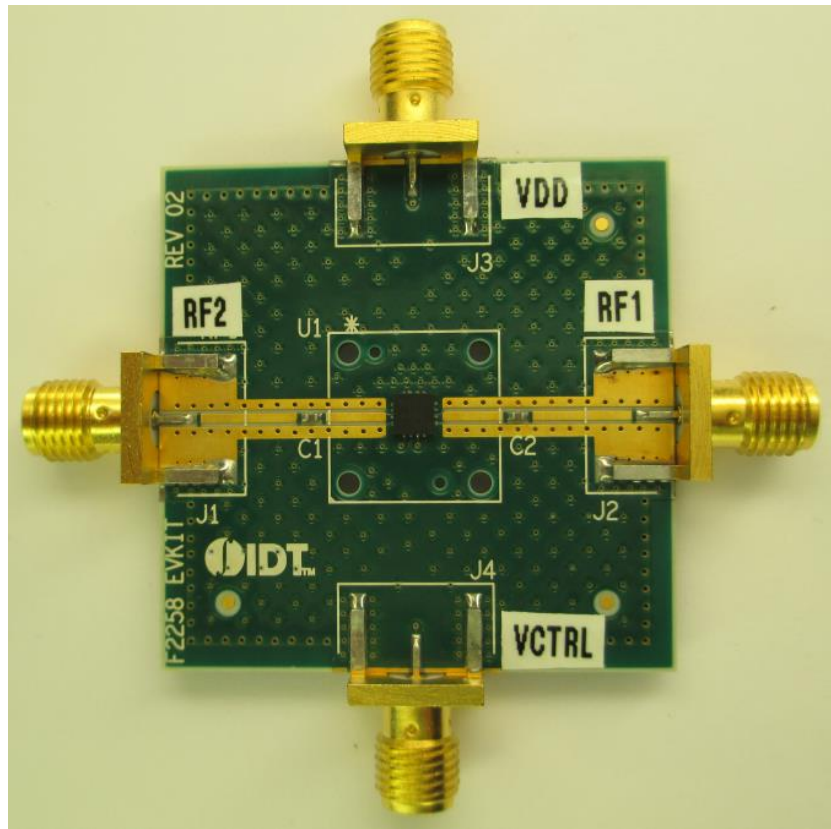

**Bottom View**

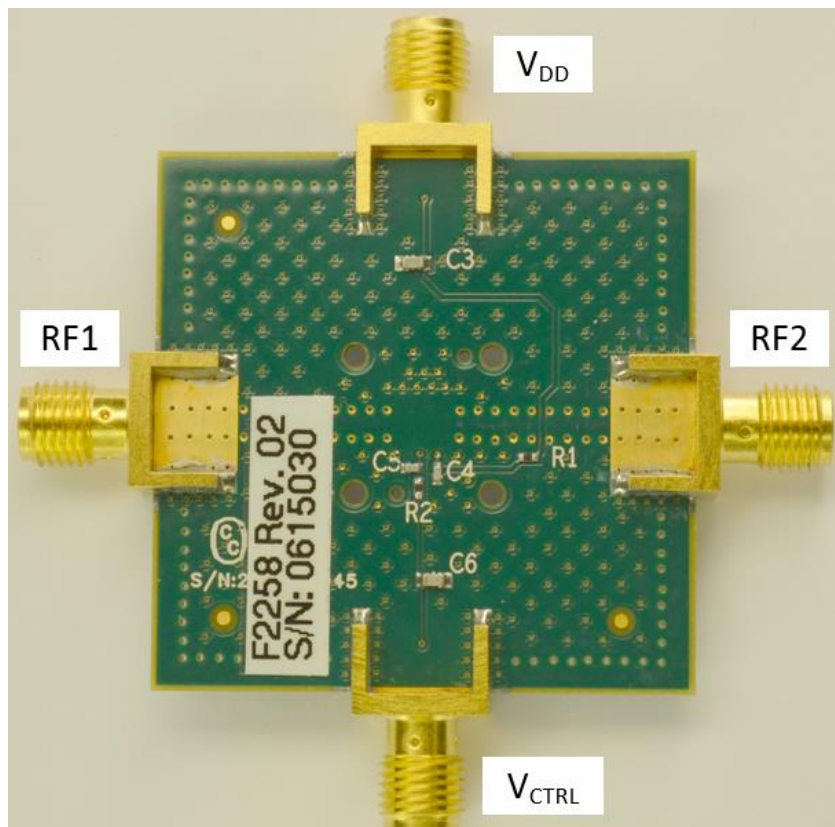

EVKIT / APPLICATIONS CIRCUIT

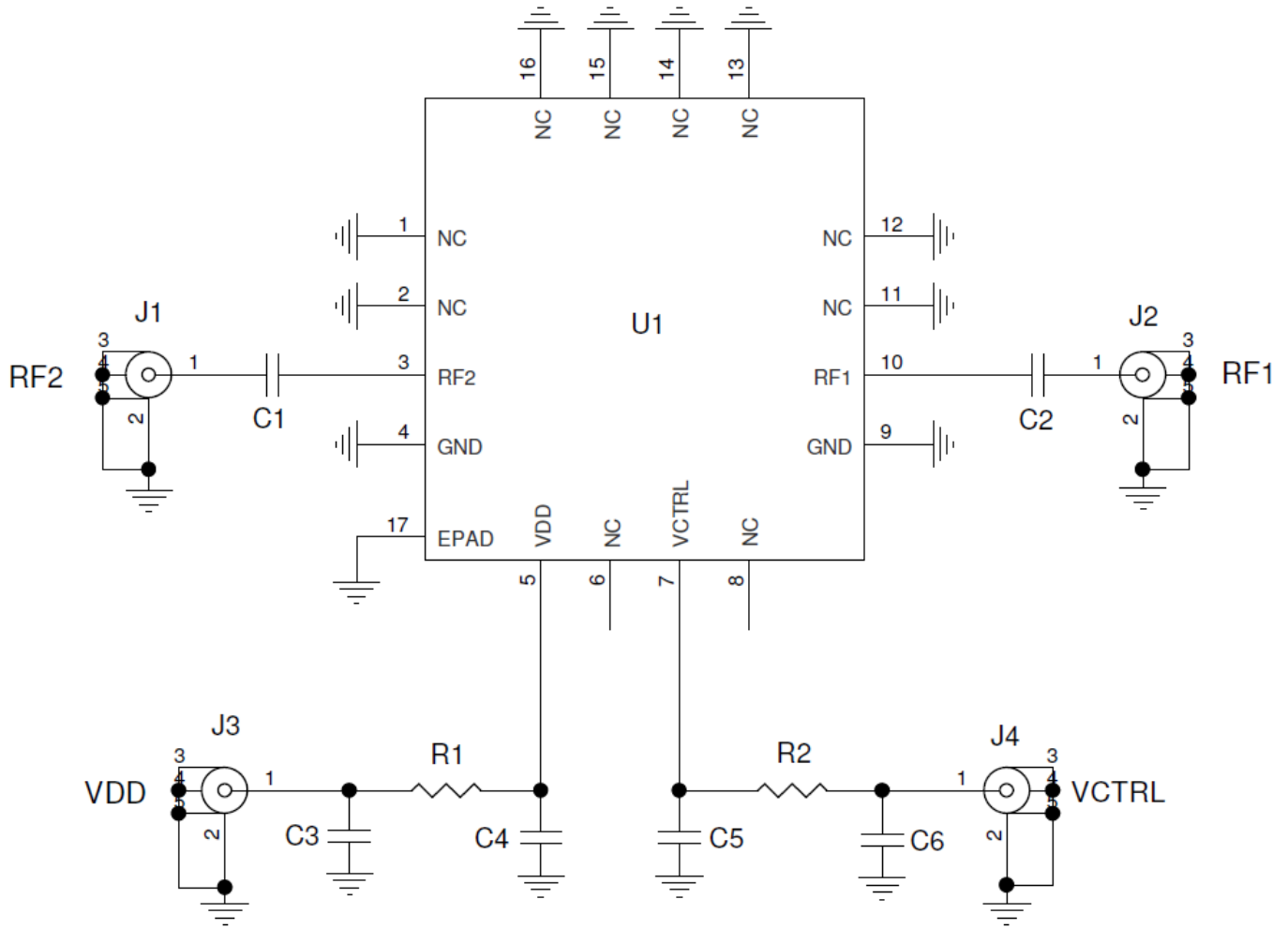

## EVKIT BOM (REV 02)

Item #	Part Reference	QTY	DESCRIPTION	Mfr. Part #	Mfr.
1	C3, C6	2	10nF ±5%, 50V, X7R Ceramic Capacitor (0603)	GRM188R71H103J	Murata
2	C4, C5	2	1000pF ±5%, 50V, C0G Ceramic Capacitor (0402)	GRM1555C1H102J	Murata
3	C1, C2	2	100pF ±5%, 50V, C0G Ceramic Capacitor (0402)	GRM1555C1H101J	Murata
4	R1, R2	2	0Ω Resistors (0402)	ERJ-2GE0R00X	Panasonic
5	J1, J2, J3, J4	4	Edge Launch SMA (0.375 inch pitch ground tabs)	142-0701-851	Emerson Johnson
6	U1	1	Voltage Variable Attenuator	F2258NLGK	IDT
7		1	Printed Circuit Board	F2258 EVKIT REV 02	IDT

## TOP MARKINGS

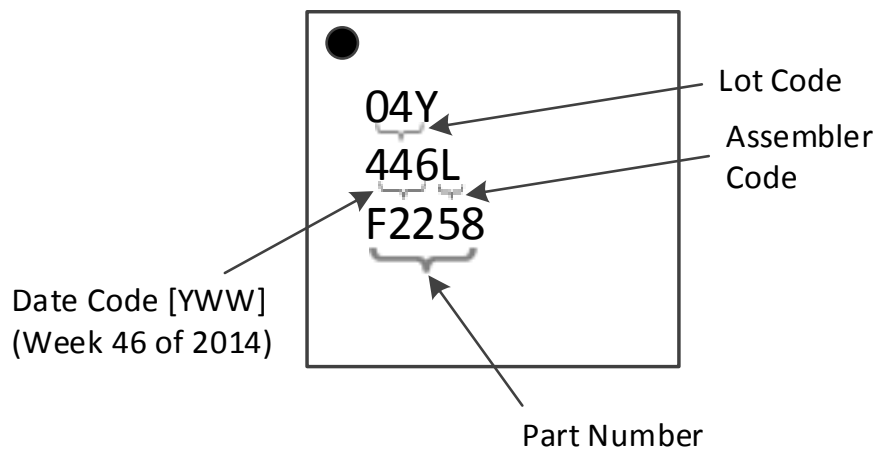

**REVISION HISTORY SHEET**

<b>Rev</b>	<b>Date</b>	<b>Page</b>	<b>Description of Change</b>
0	2015-Aug-03		Initial Release
1	2017-Jan-20	4	Increased the Max limits for $I_{DD}$ and $I_{CTRL}$



**Corporate Headquarters**  
6024 Silver Creek Valley Road  
San Jose, CA 95138 USA

**Sales**  
1-800-345-7015 or 408-284-8200  
Fax: 408-284-2775  
www.idt.com

**Tech Support**  
<http://www.idt.com/support/technical-support>

DISCLAIMER Integrated Device Technology, Inc. (IDT) reserves the right to modify the products and/or specifications described herein at any time, without notice, at IDT's sole discretion. Performance specifications and operating parameters of the described products are determined in an independent state and are not guaranteed to perform the same way when installed in customer products. The information contained herein is provided without representation or warranty of any kind, whether express or implied, including, but not limited to, the suitability of IDT's products for any particular purpose, an implied warranty of merchantability, or non-infringement of the intellectual property rights of others. This document is presented only as a guide and does not convey any license under intellectual property rights of IDT or any third parties.

IDT's products are not intended for use in applications involving extreme environmental conditions or in life support systems or similar devices where the failure or malfunction of an IDT product can be reasonably expected to significantly affect the health or safety of users. Anyone using an IDT product in such a manner does so at their own risk, absent an express, written agreement by IDT.

Integrated Device Technology, IDT and the IDT logo are trademarks or registered trademarks of IDT and its subsidiaries in the United States and other countries. Other trademarks used herein are the property of IDT or their respective third party owners.

Copyright ©2015. Integrated Device Technology, Inc. All rights reserved.